

DM

Draper

Dining Table

London

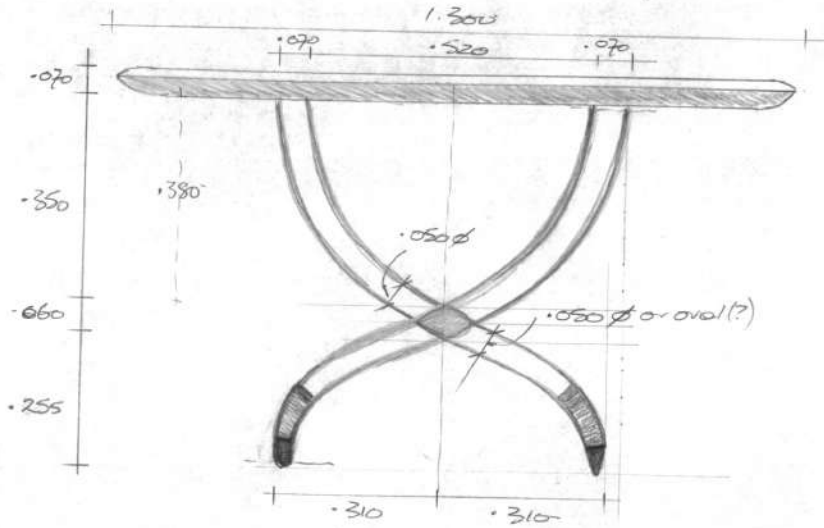
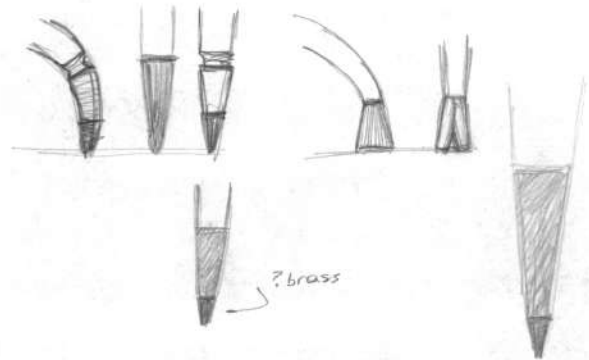

End Elevation - Dining Table
for BUTE HOUSE

Scale 1:10
April '90



3.

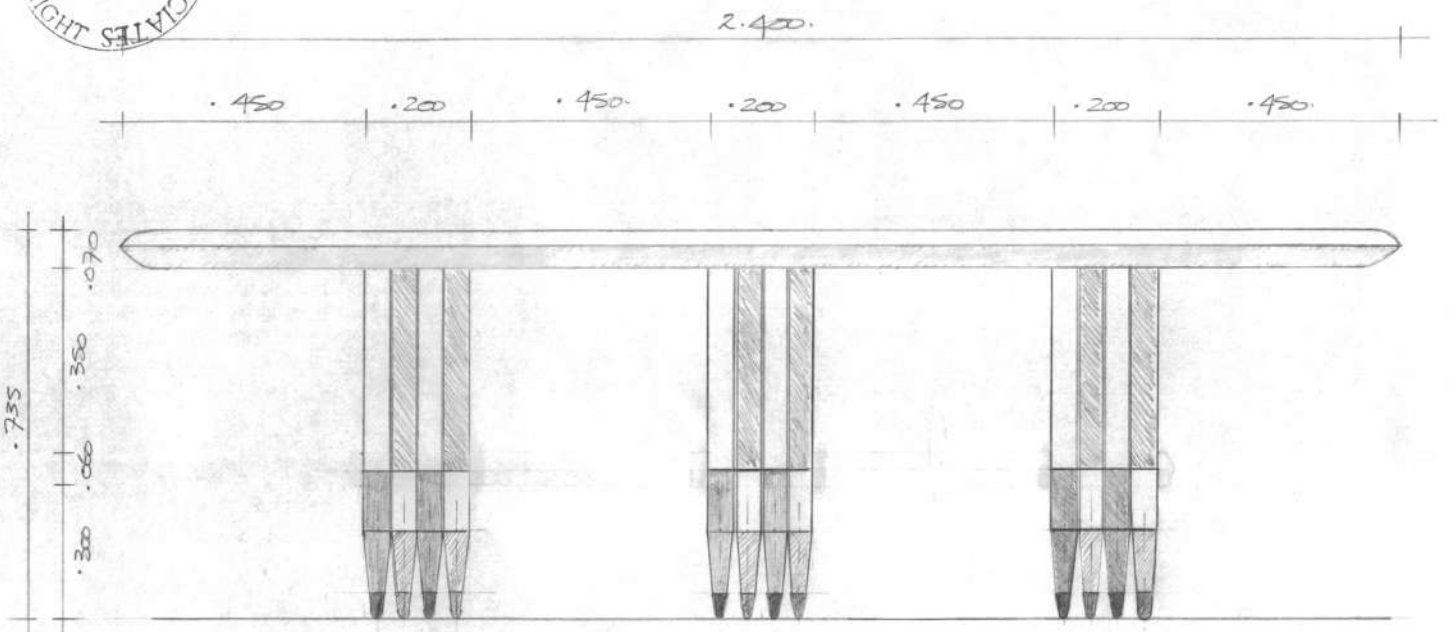

Long Elevation
Dining Table for Bute House

Scale 1:10.
April '90

Table for 10 (no) max (?)
(4 each side / 1 at
each end).
2.400 x 1.300.

1.

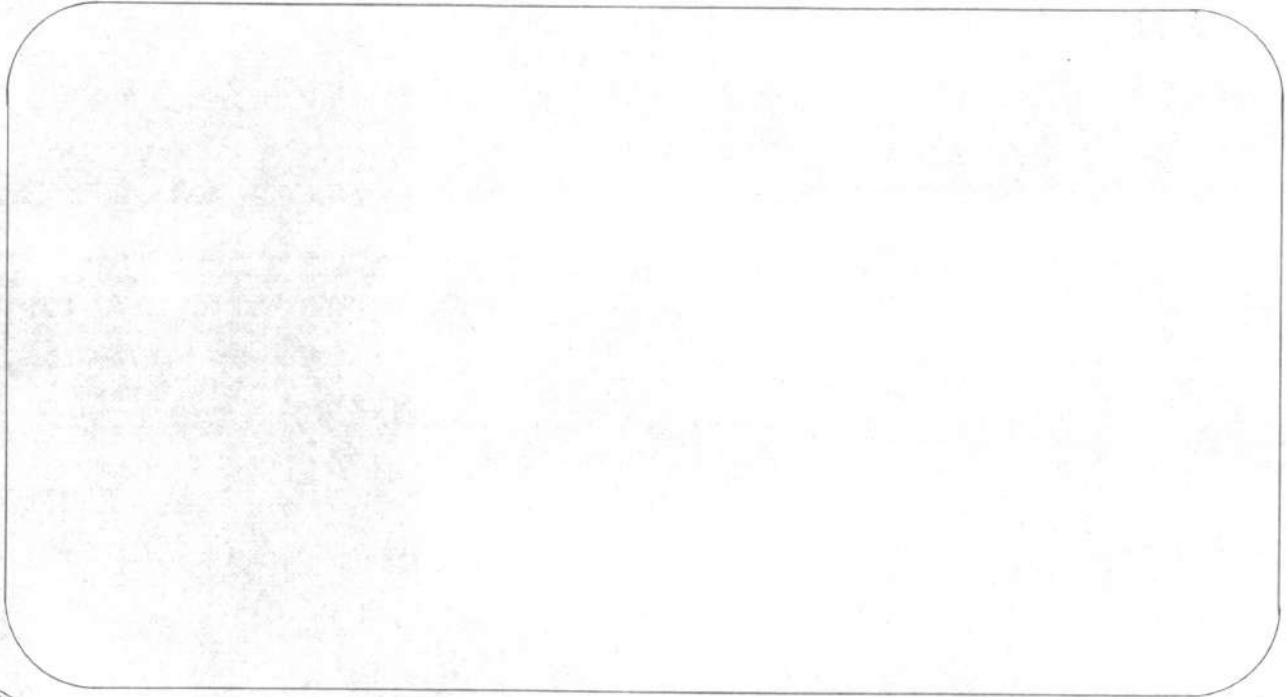

PLAN PROPOSED DINING TABLE.

Scale 1:10
April 1990

END ELEVATION - DINING TABLE
FOR BOTE HOUSE

1:5 2.
April '90.

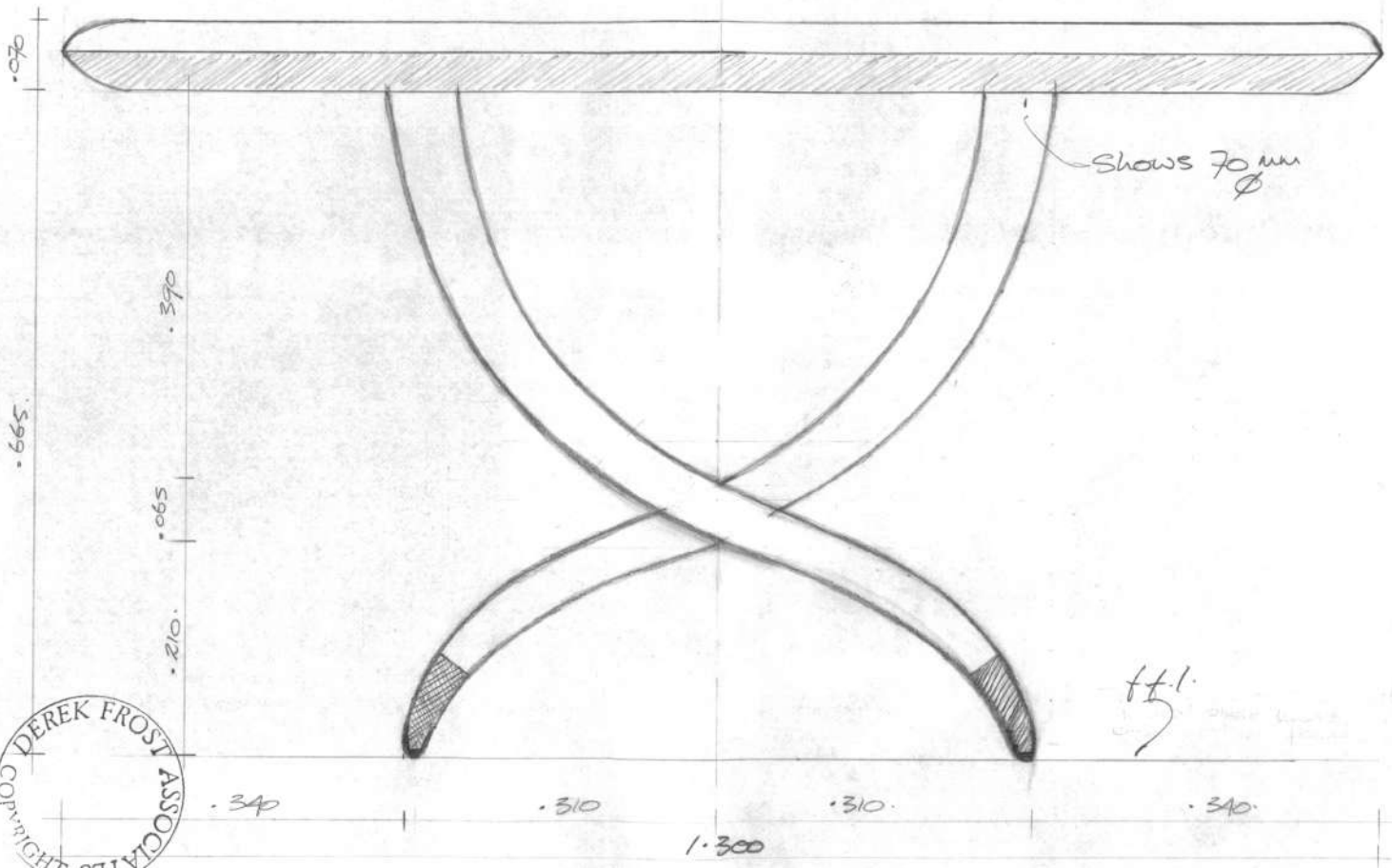

To show gap between
pairs of legs

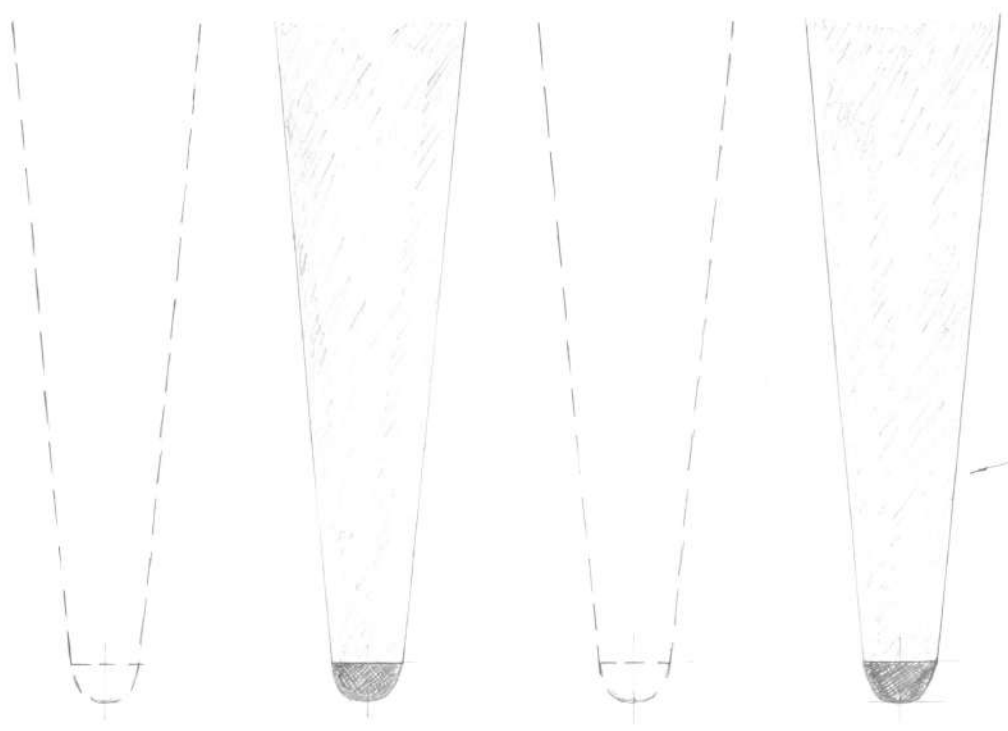

Angle not
to scale



Dump Table
Bute House.

Full Scale
April '90



Table for 10 max. (2.40 x 1.30).
(4 each side / 1 at
each end).

- 12 (no.) legs
(4 x 3 blocks).

4.

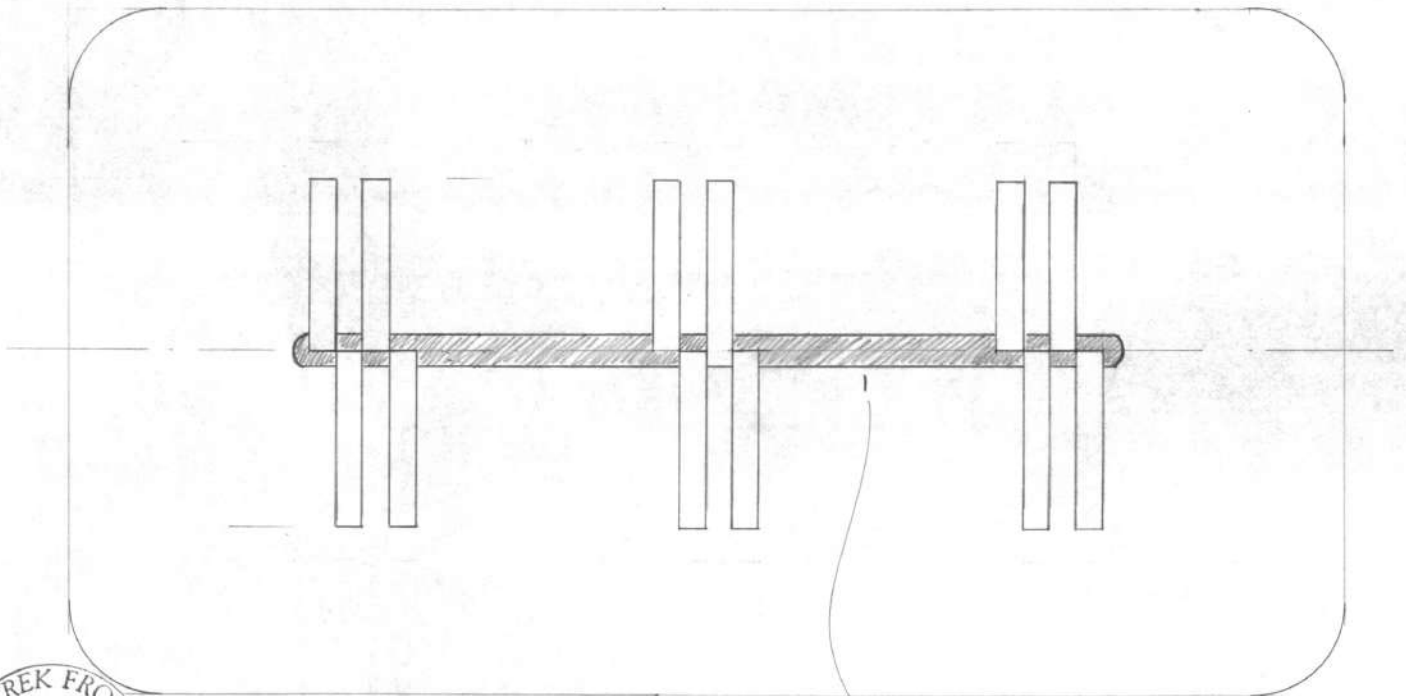

? omit connecting
stretcher / see
comment sketch
no. 3.

scale 1:10
April '90.

2.40 x 1.30.
overall.

20.

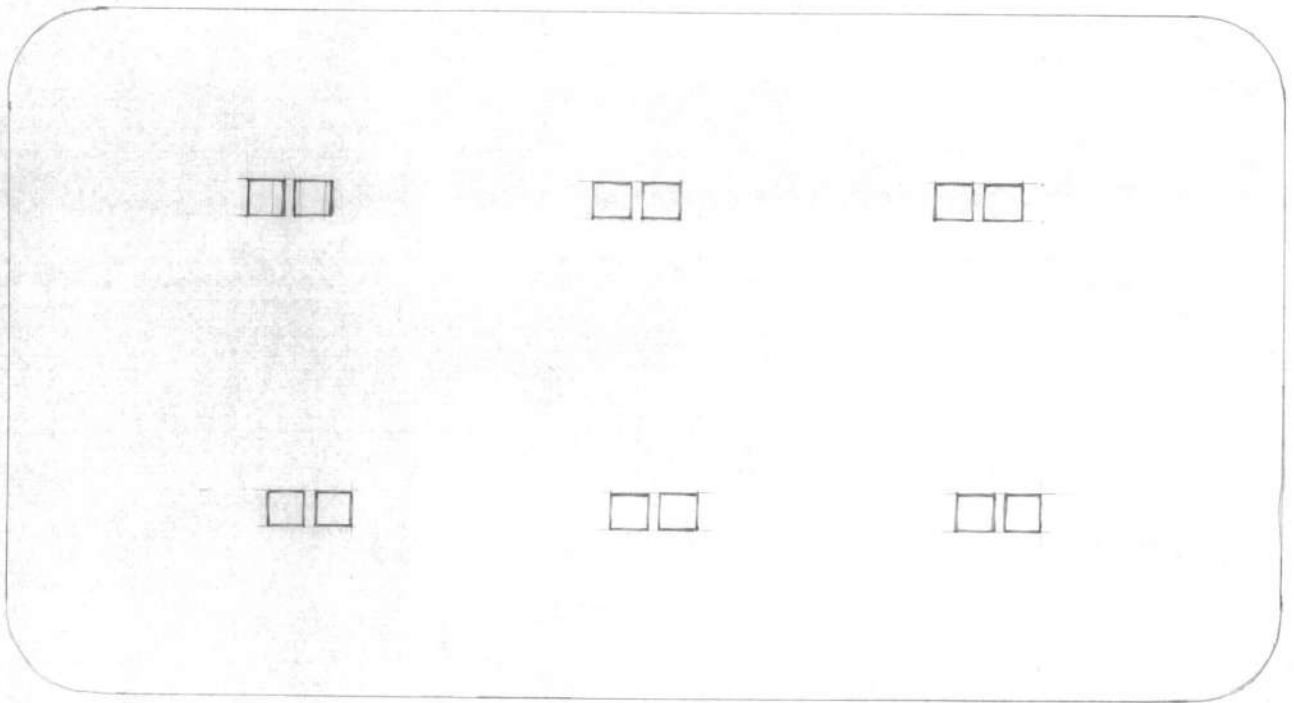

PLAN PROPOSED DINING TABLE
BUTE HOUSE.

scale 1:10
1704 '90.

Tip details
- not to scale.

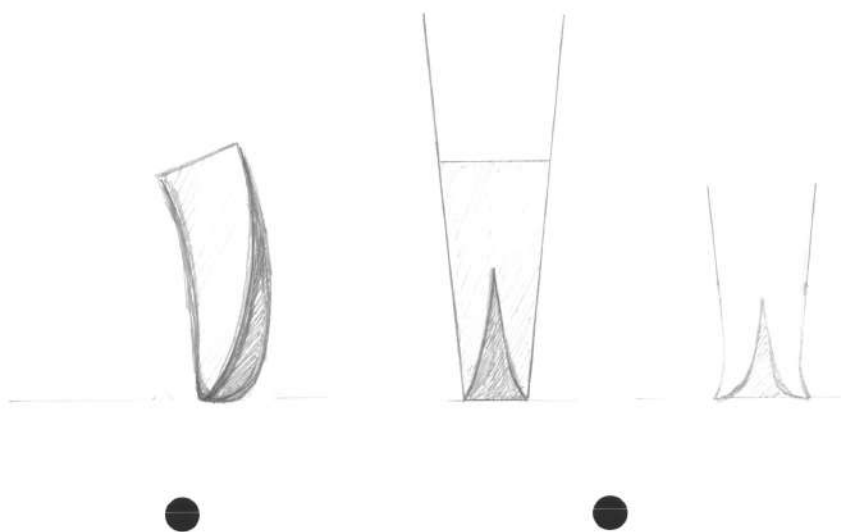

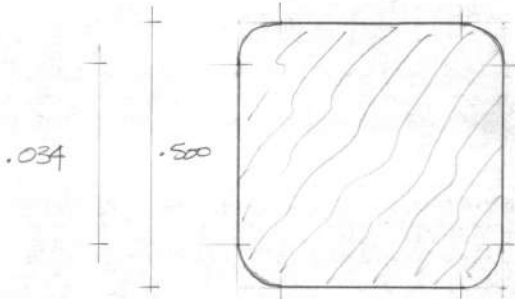

FULL SCALE SECTION
THRU CURVING LEG AT
SQUARE / ROUNDED CORNER
SECTION
- GRADUALLY BECOMES
CURVED (?) ABOVE + BELOW.
CIRCULAR

DINING TABLE FOR
BUTE HOUSE

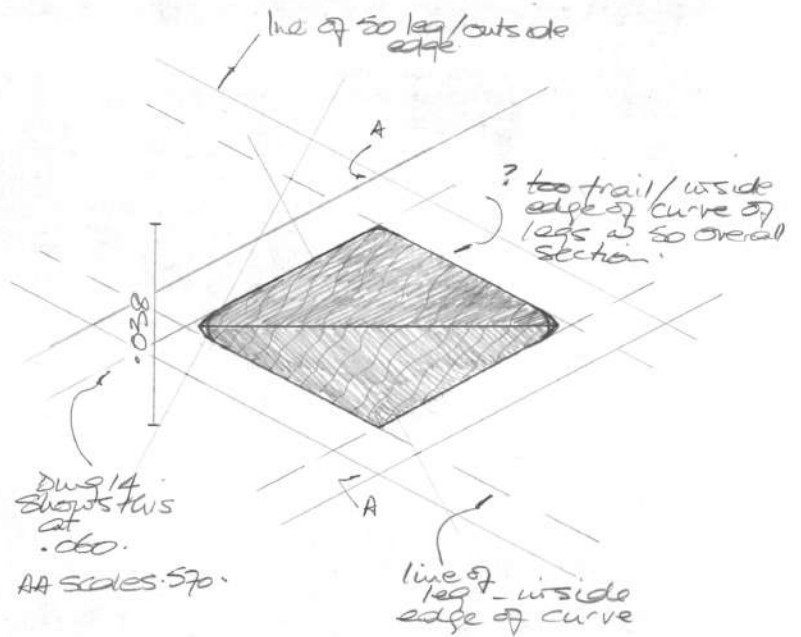

Leave space down centre
for flowers / candles ? or fill

29.

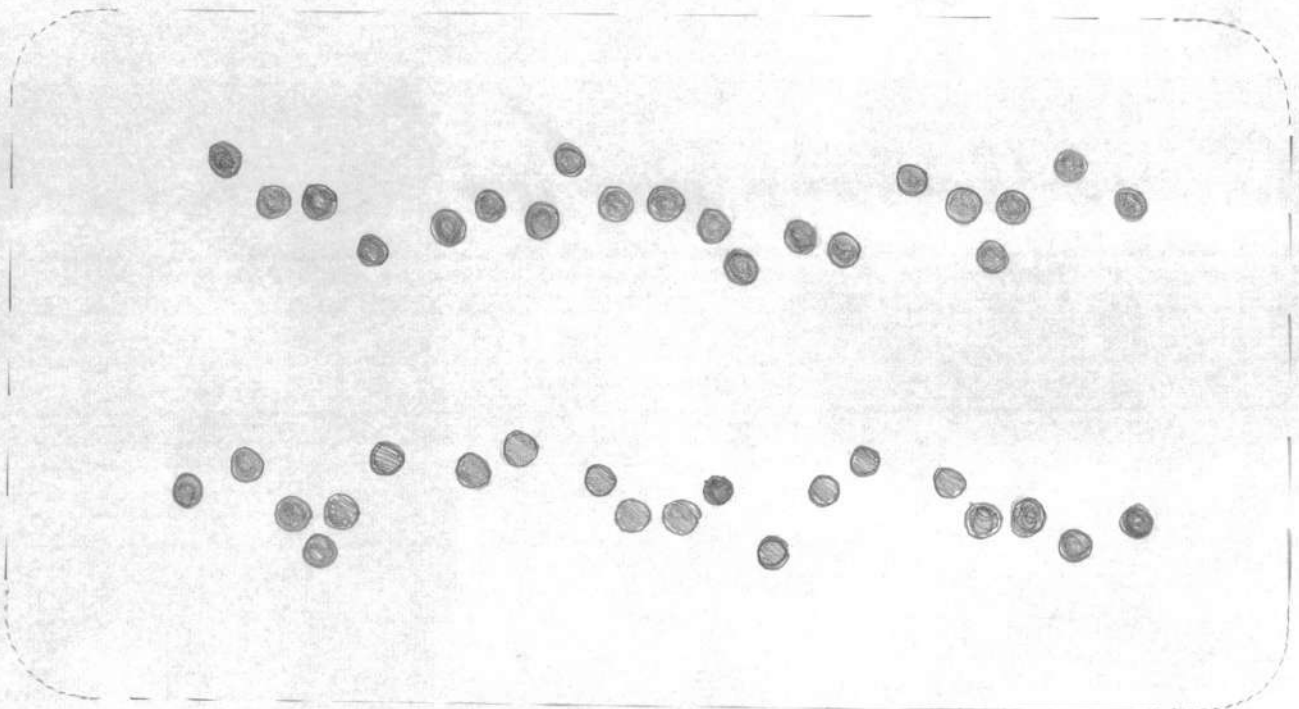

Plan Top
Dining Table for Butte House.

scale 1:10.
June '90

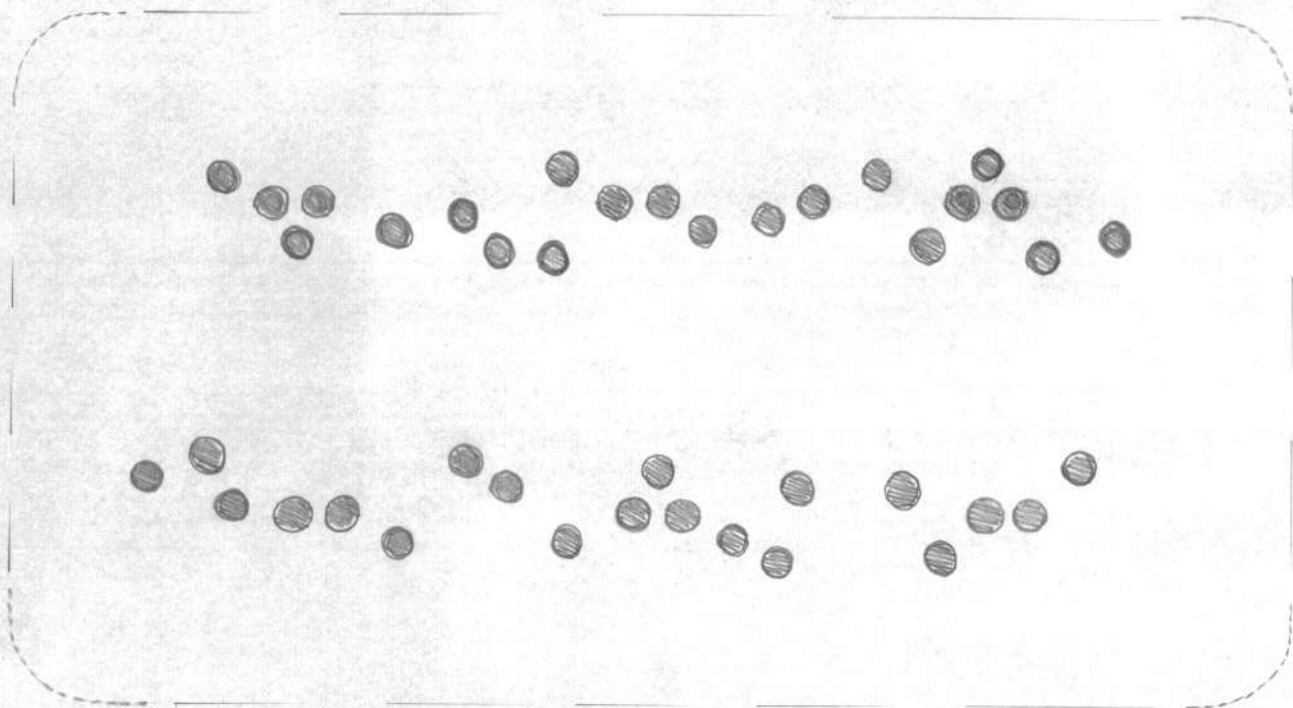

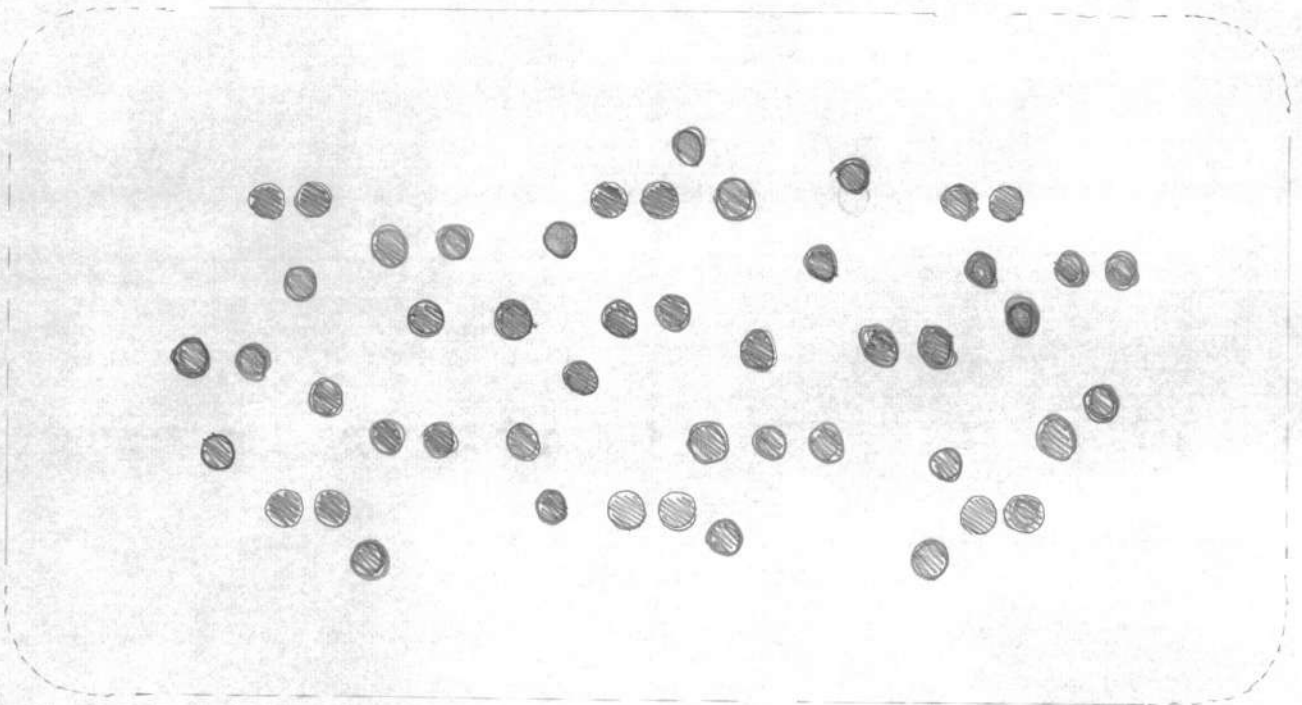

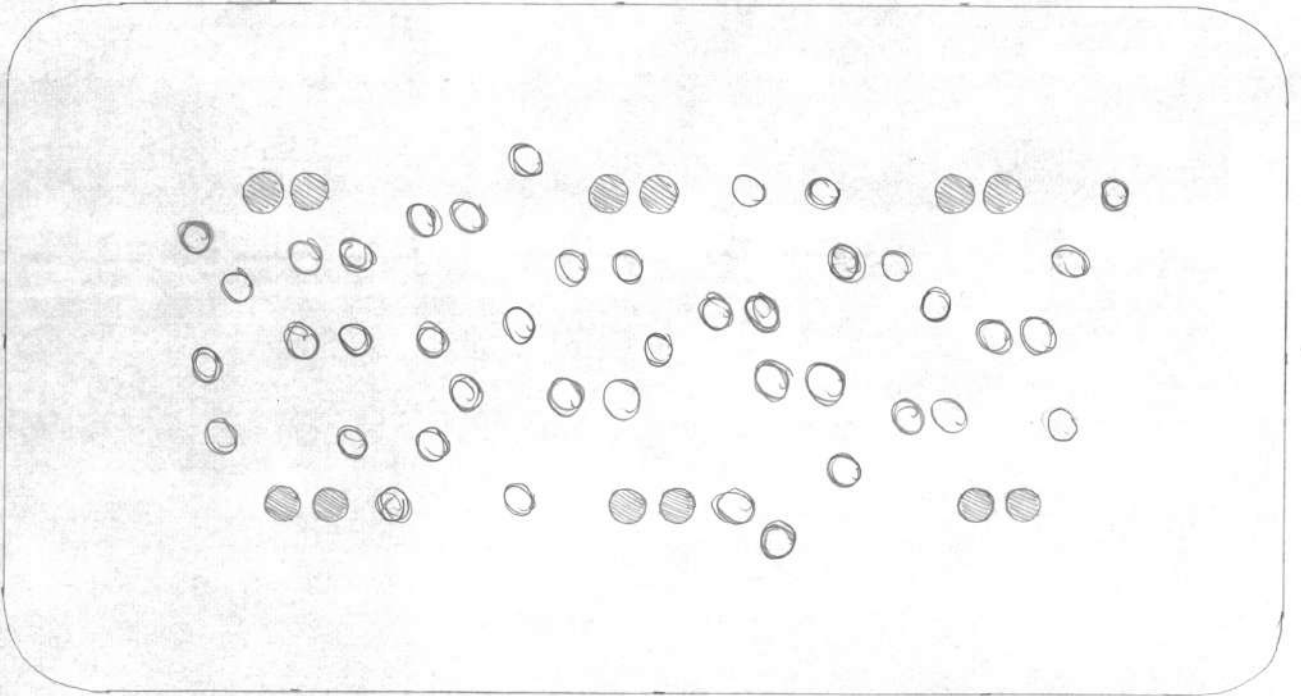

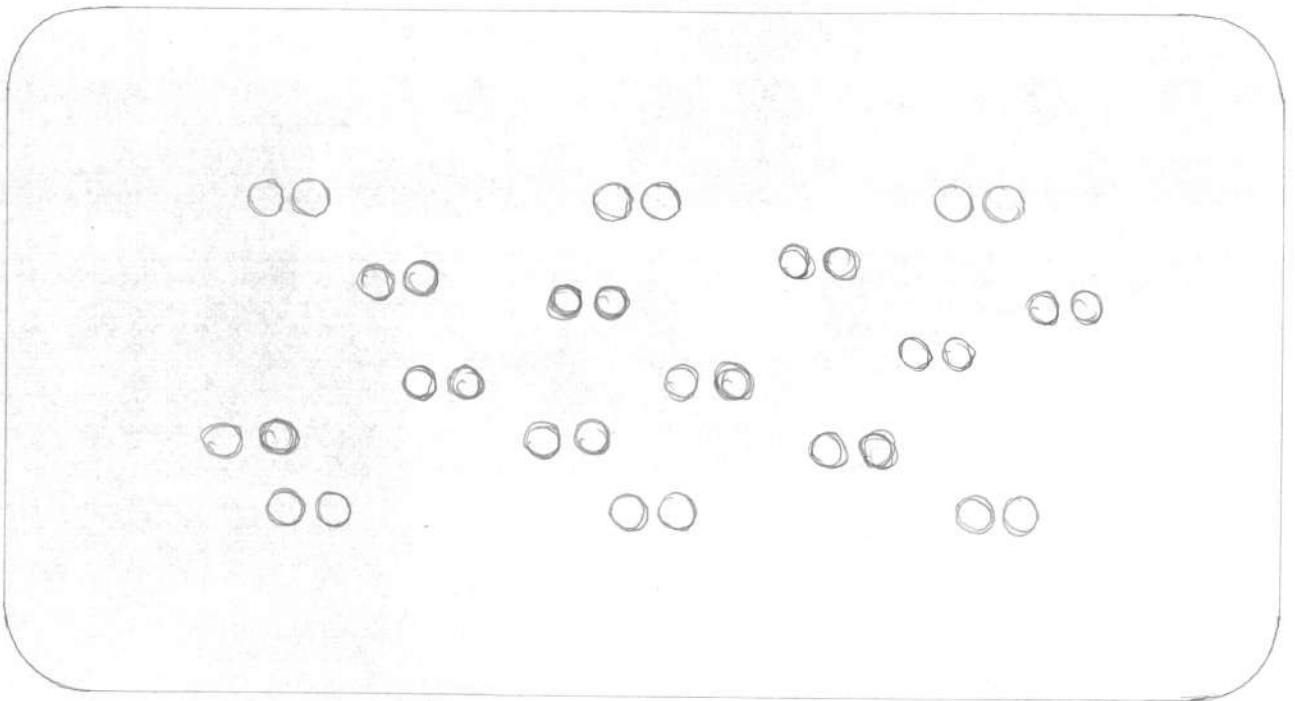

DINING TABLE - BUTE HOUSE
PLAN.

Scale 1:10.
May '90

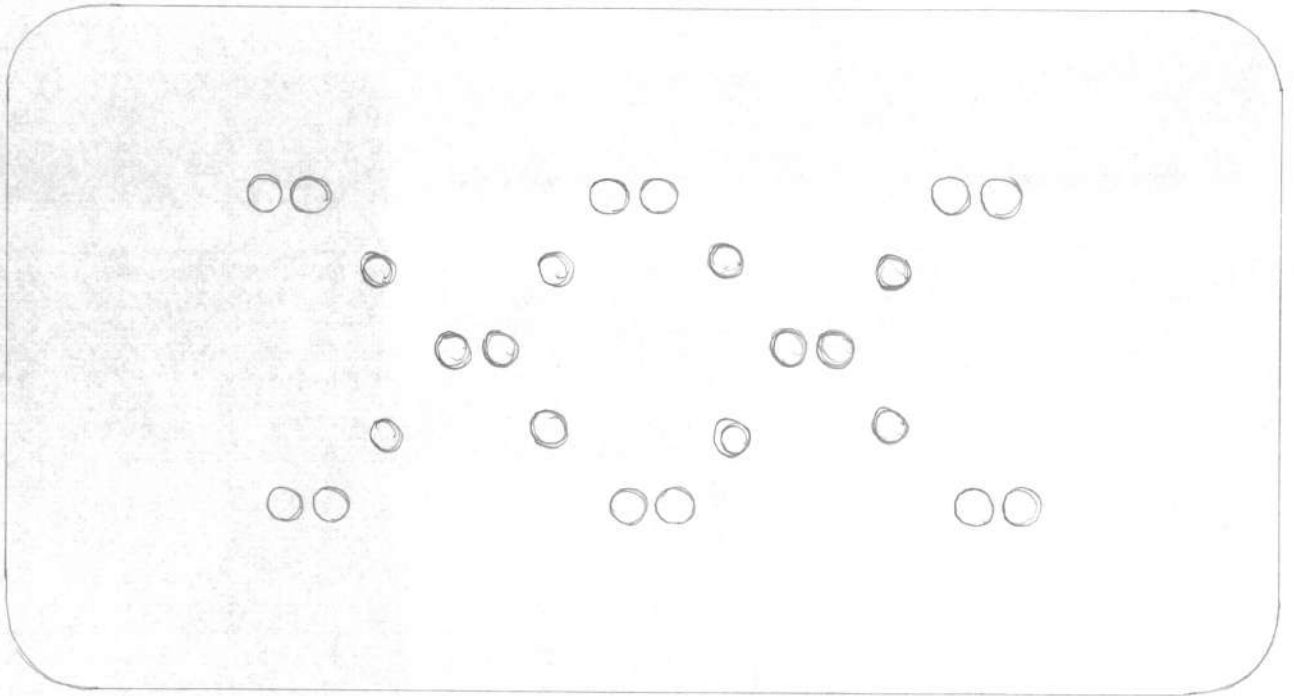

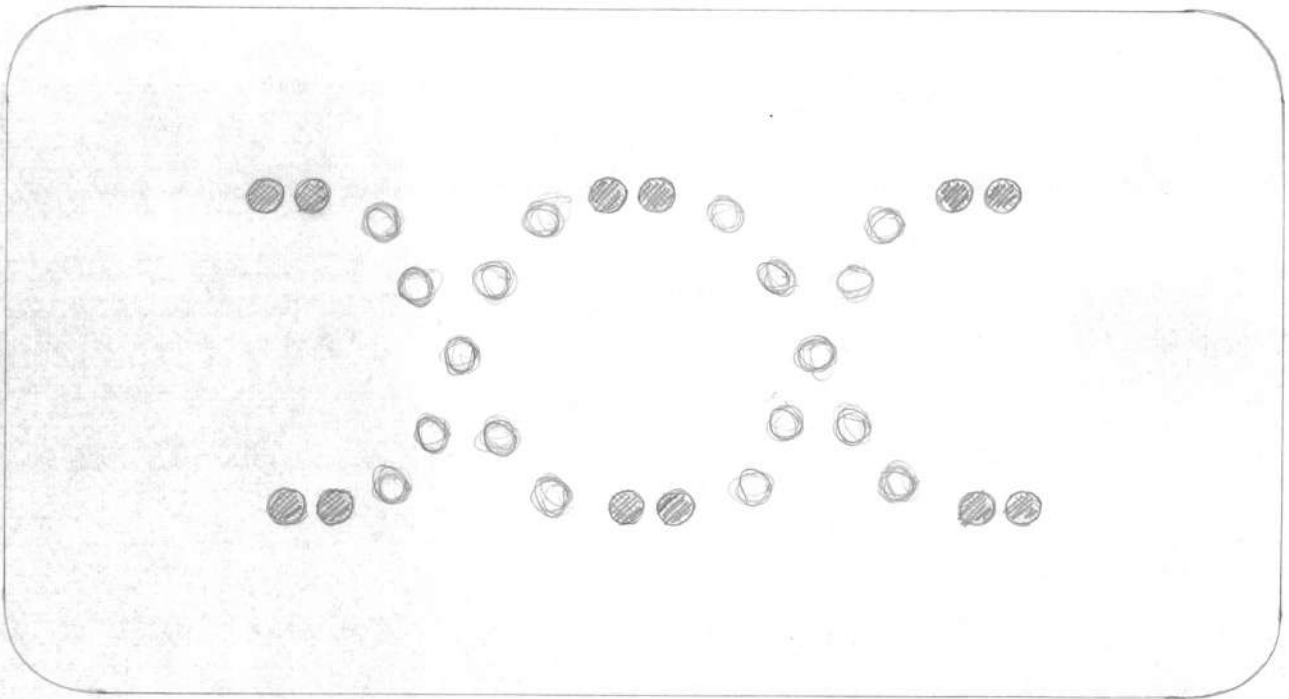

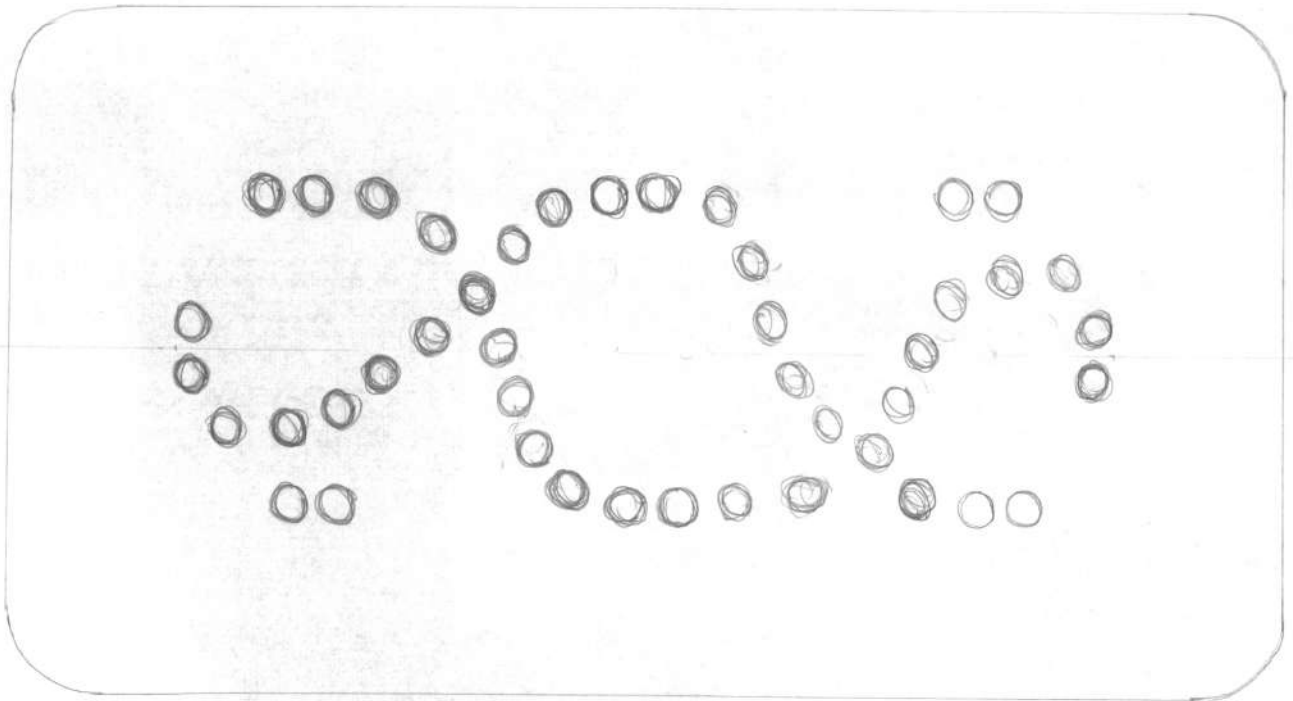

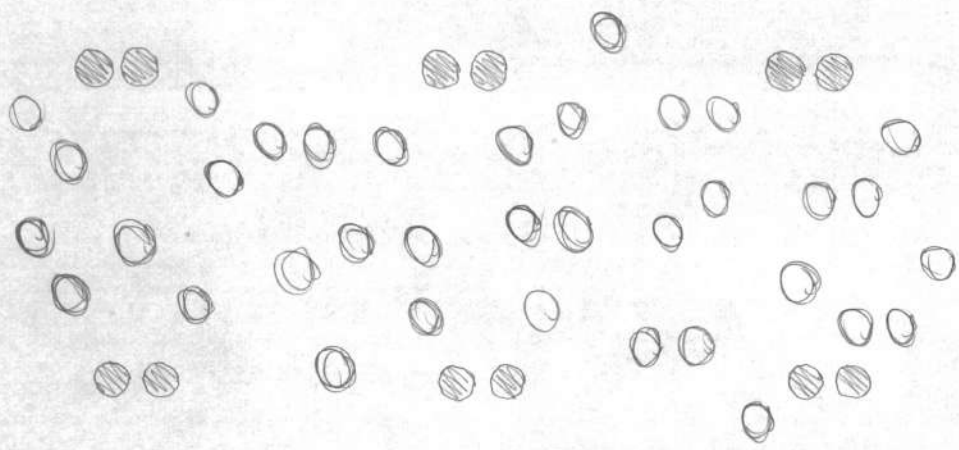

PLAN - SHOWING POSITION TOP
OF 70 mm \varnothing LEGS/HORNS UNDER.

7.

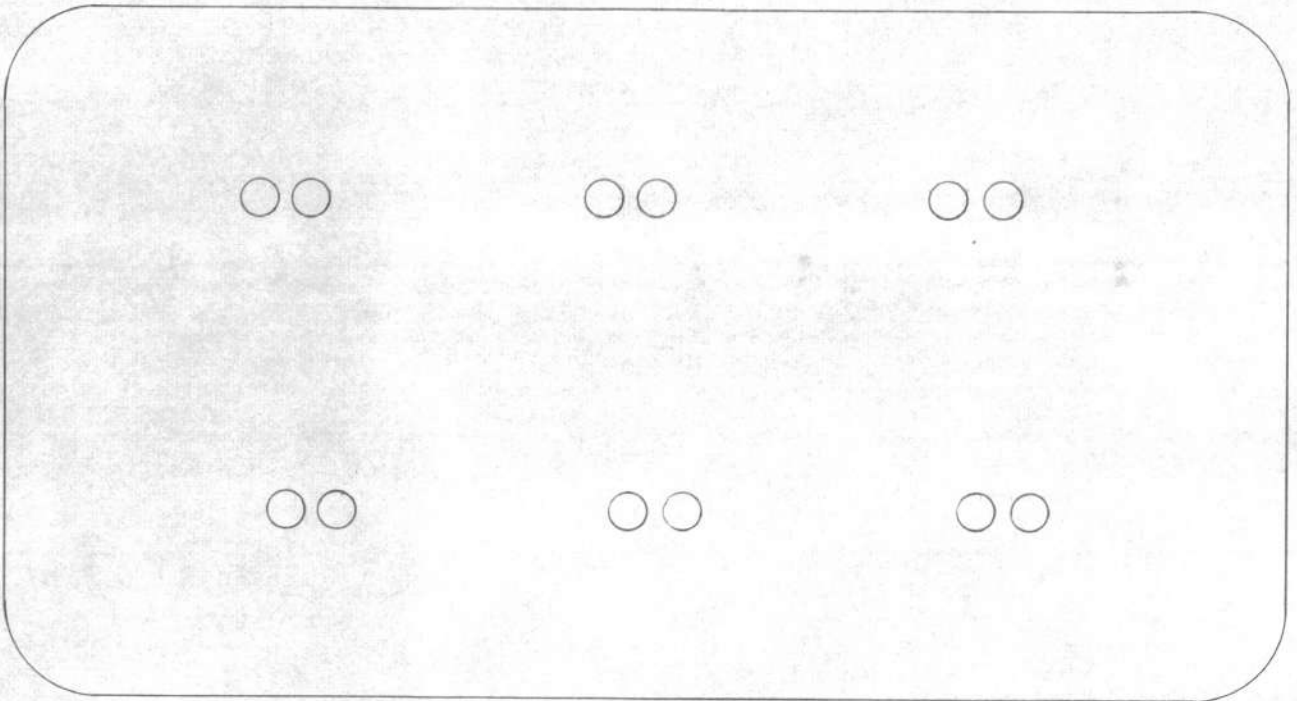

PROPOSED DINING TABLE
FOR BUTE HOUSE.

Scale 1:10
June 190.



Construction altered
on advice makers.

1.

2.400

430

1.540.

.430

inlaid flush circles/
patinated metal.

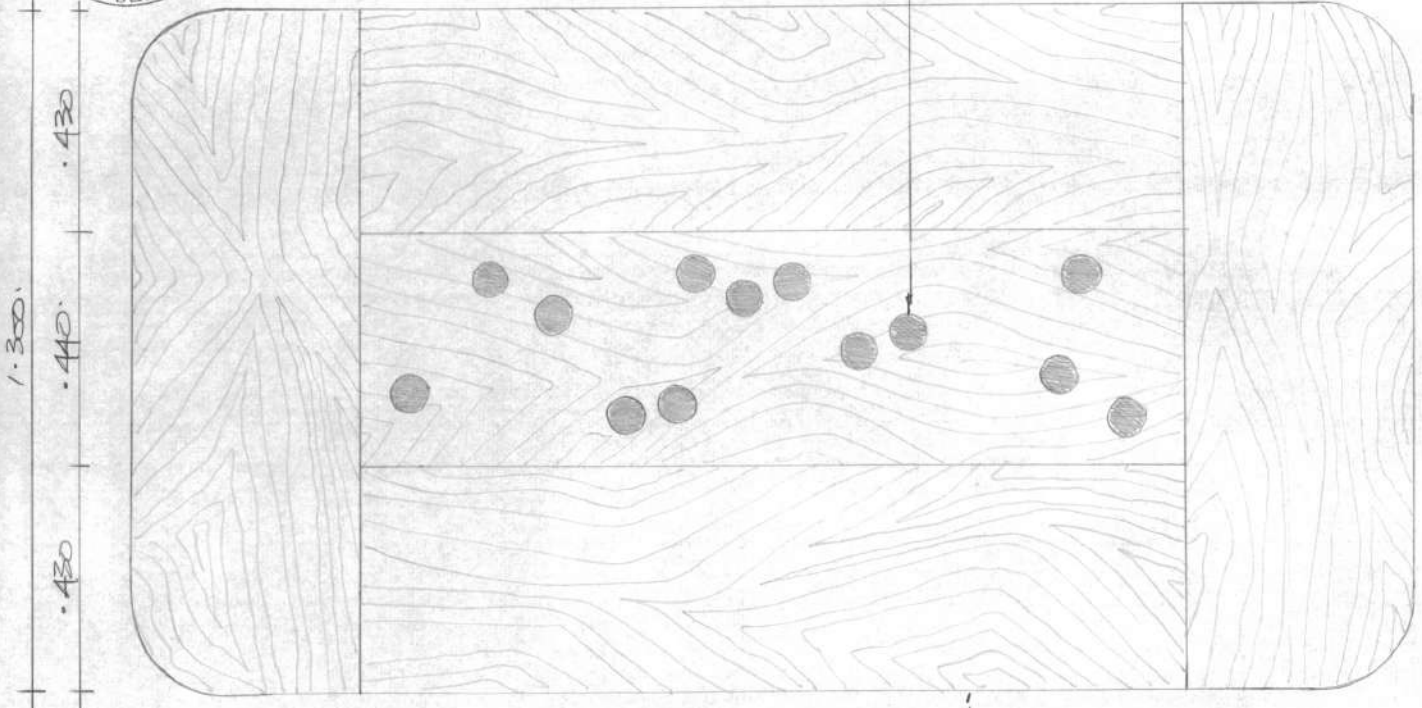

Plan of Top - OAK
Proposed Dining Table
Bute House.

Contrast hardwood to
edge - see profile dwg.

Scale 1:10
June 190.

SURFACE DOT LAYOUT.
(NB - tie up to floor above).

420

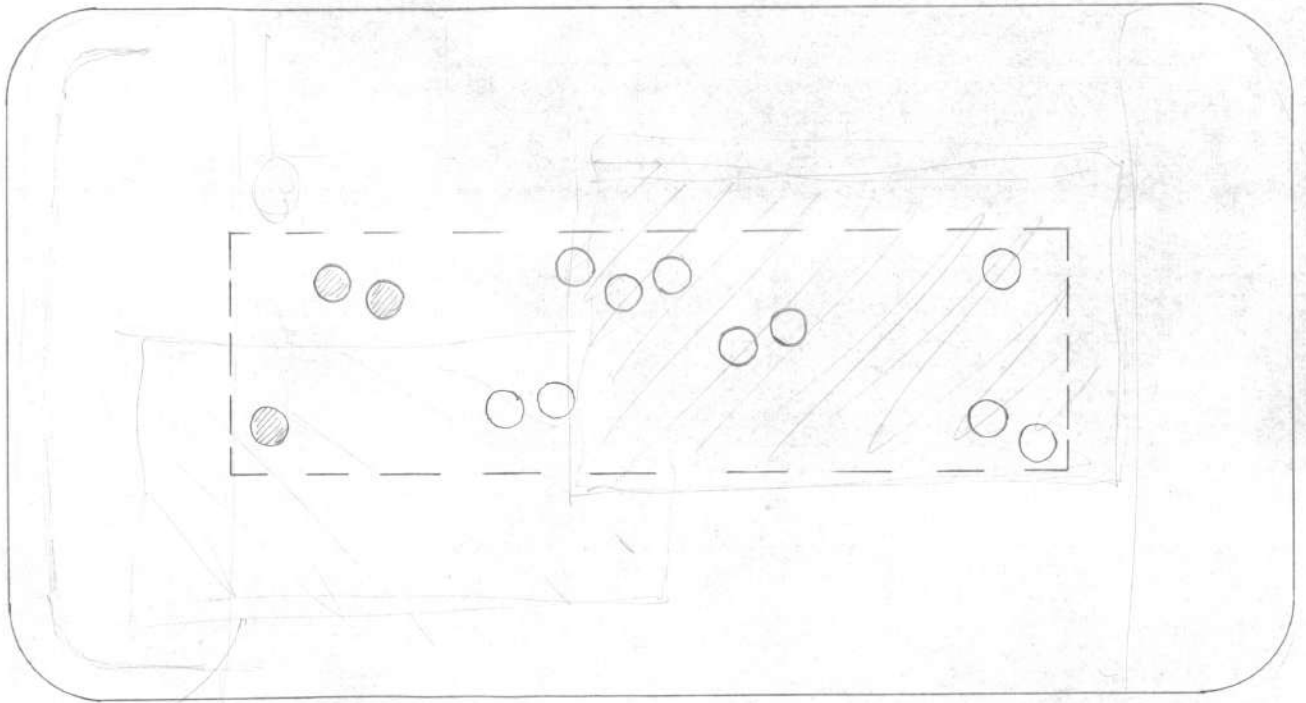

420

Shu

PROPOSED DINING TABLE
FOR BUTE HOUSE.

Scale 1:10
June '90

N.B. No space
side board except
where shown
dotted.

? ok rod immediately
under picture.

Oval Dining Table
2.500 x 1.500 x
.730 high



DINING TABLE FOR
BUTE HOUSE.

Scale 1:50.
Feb '90.

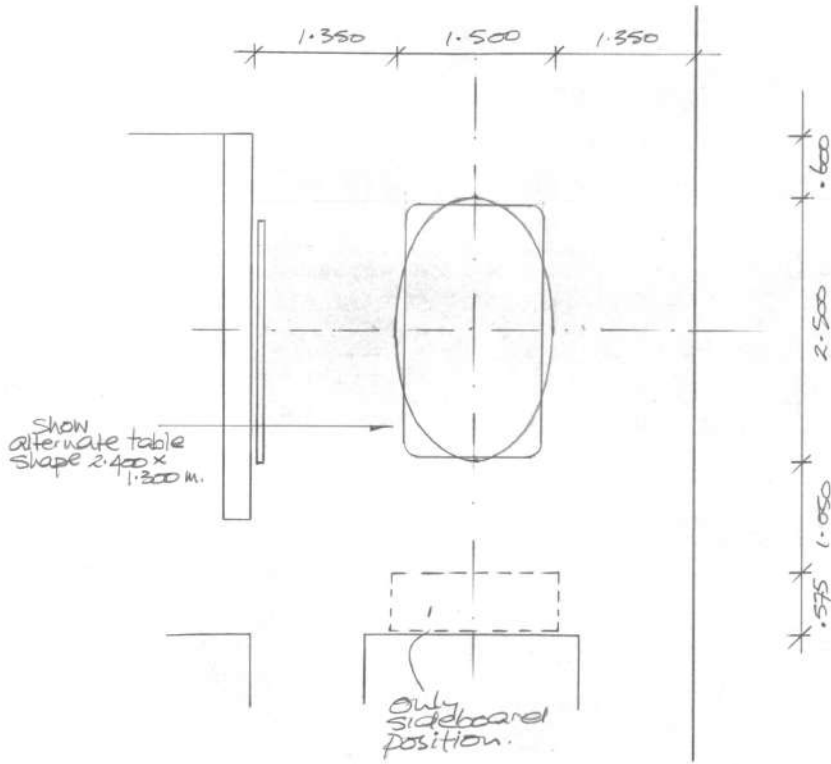



4.

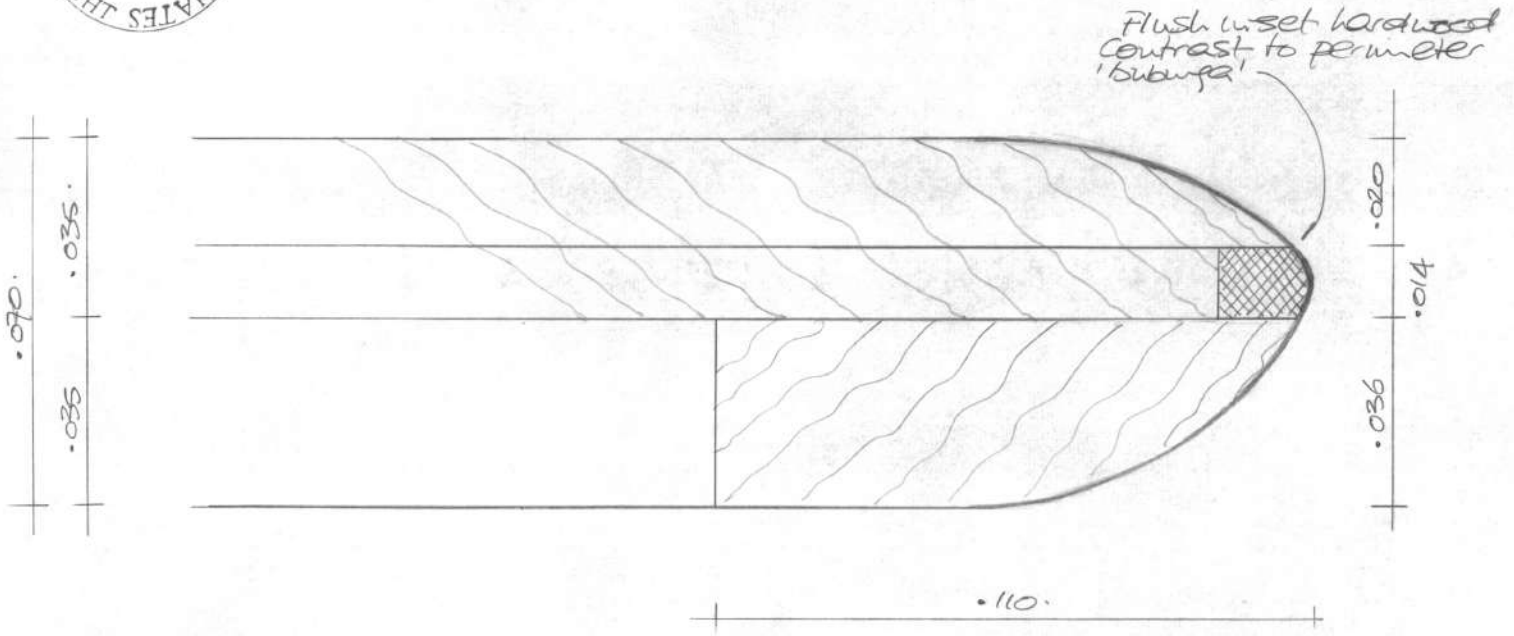

SECTION / SIDE ELEVATION
EDGE PROFILE
DINING TABLE - BUTE HOUSE

FULL SCALE
JUNE '90.

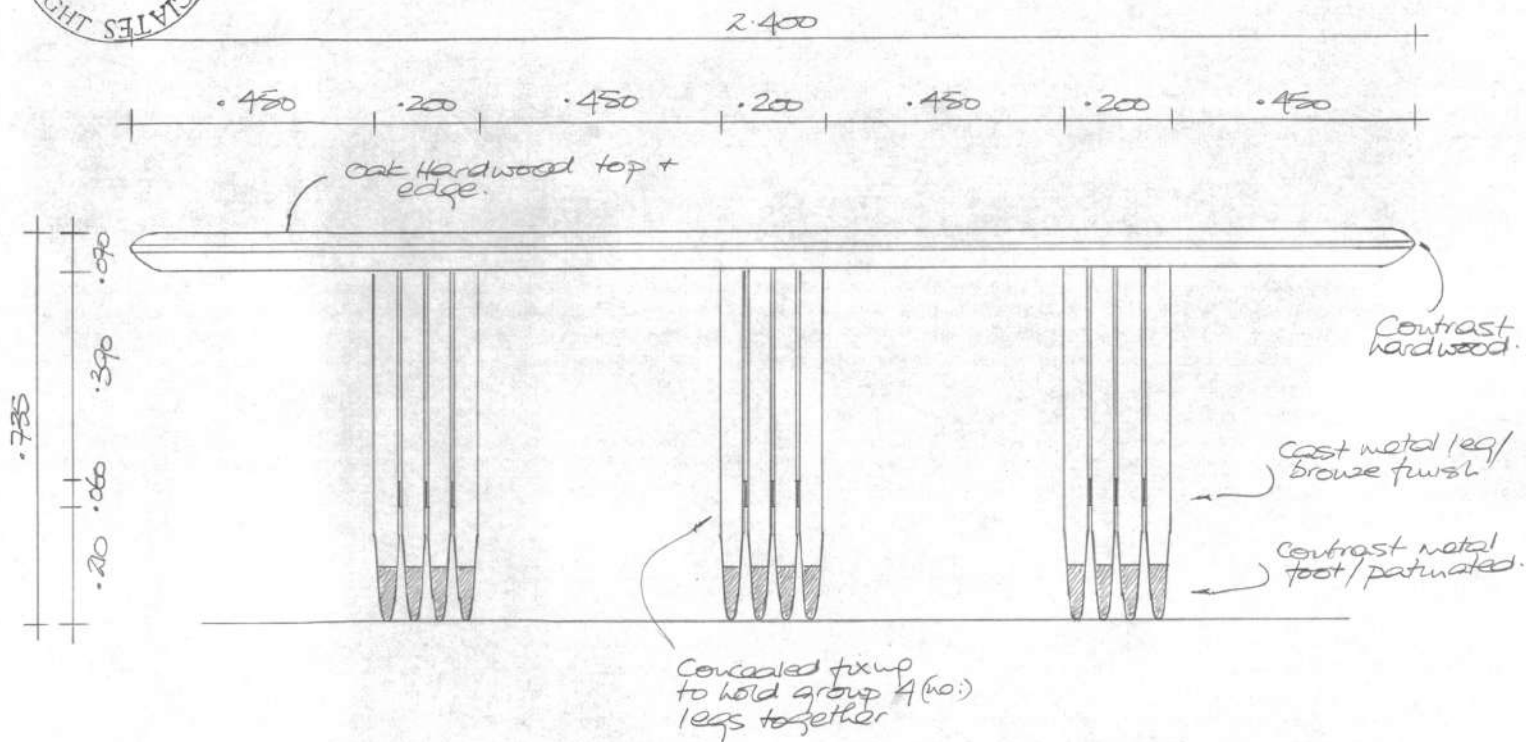

LONG ELEVATION
DINING TABLE FOR BUTE HOUSE
PROPOSED

Scale 1:10
June '90



? Turned plants re: grain at butted joints

2-400.

1

Acid patinated bronze discs set flush in top.

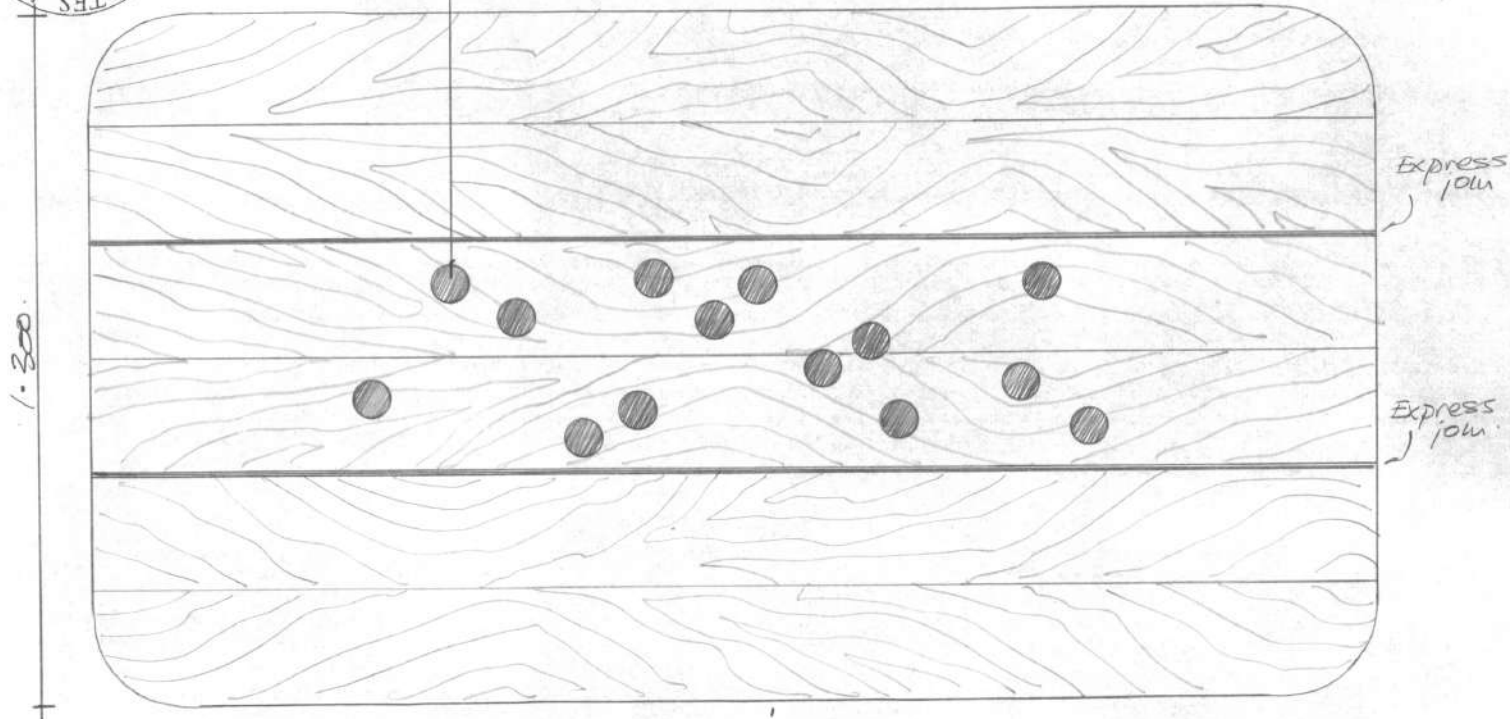

Plan of Oak Top
Proposed Dining Table
Bute House

↳ tubunga contrast to edge / see full scale profile.

Scale 1:10
June '90.

Overall width 1.300 m.

1/5
Tune '90. 2.

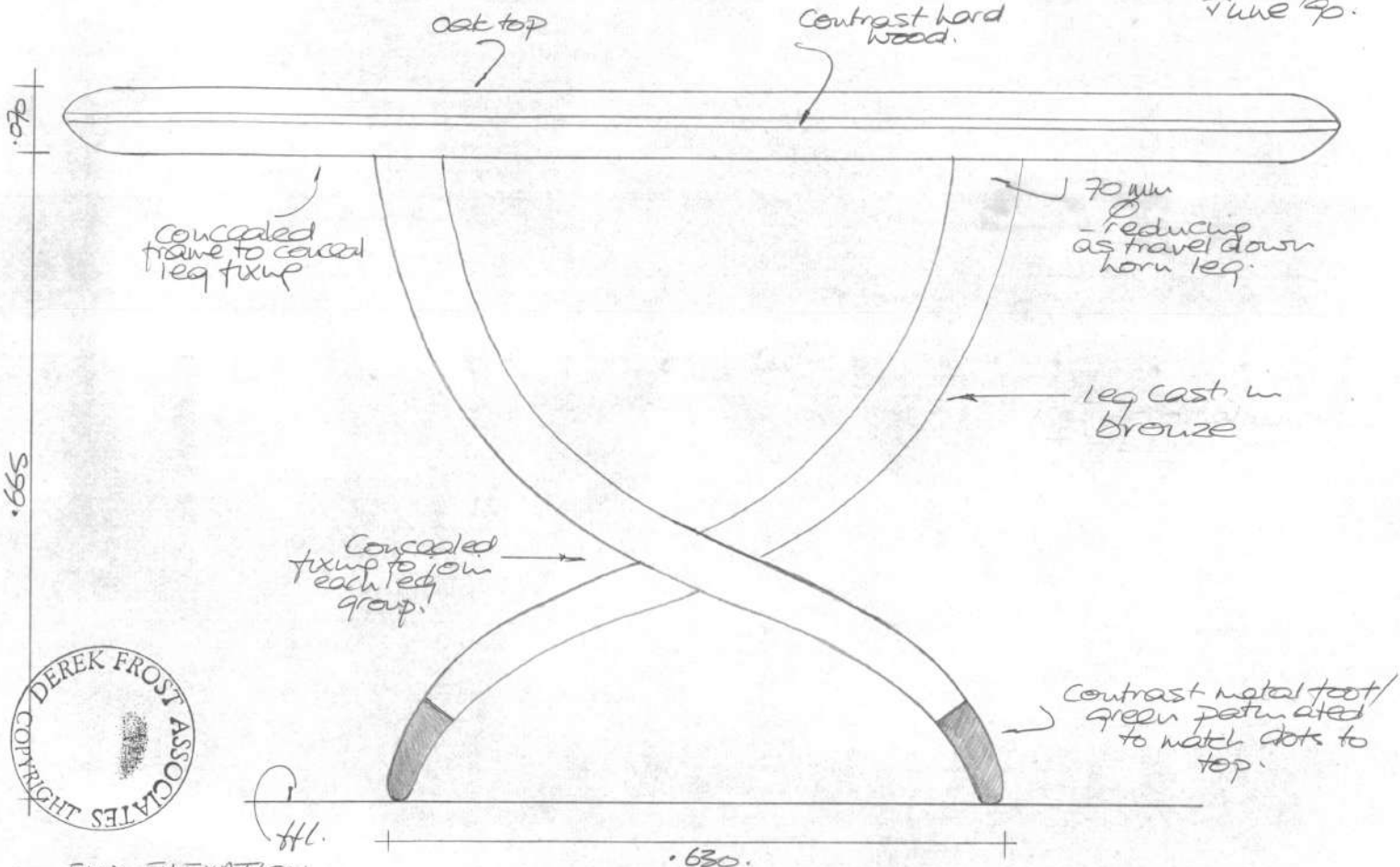

END ELEVATION
DINING TABLE FOR BUTE HOUSE
PROPOSED.



DN

Draper

Bedside Tables

London

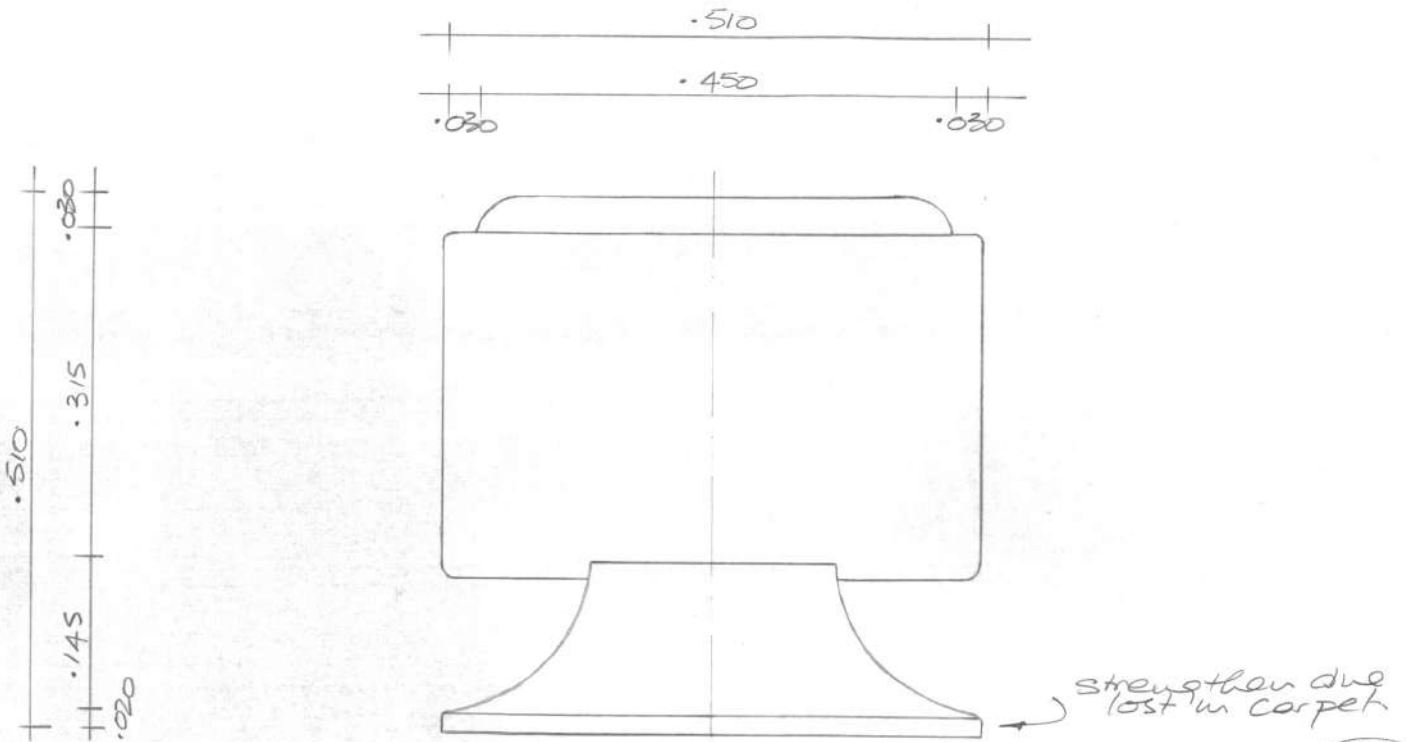

SIDE ELEVATION

PROPOSAL - PAIR OF
BEDSIDE CABINETS
FOR MASTER BED ROOM
BUTE.



1:5 JAN '91.

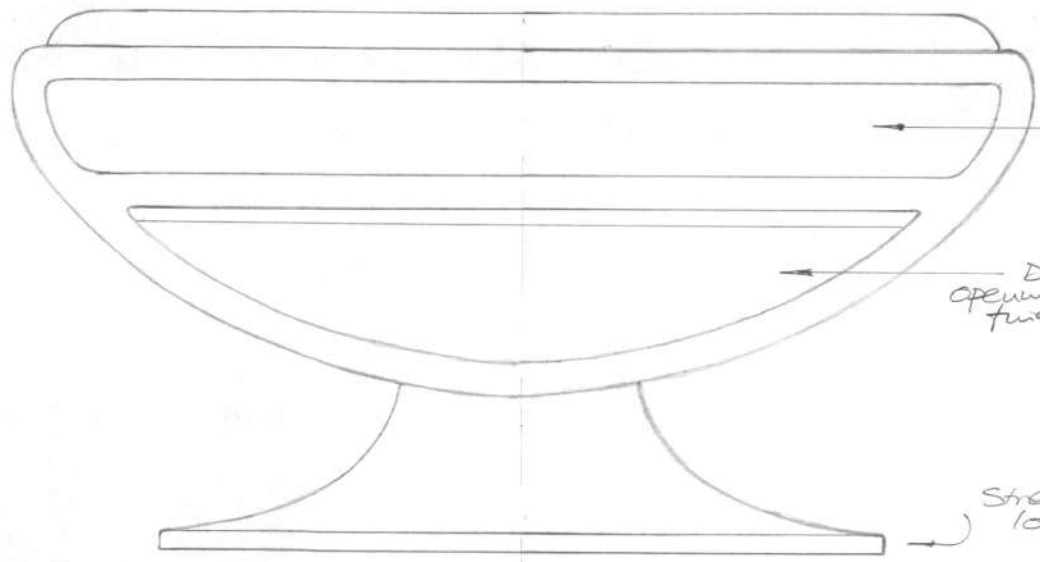
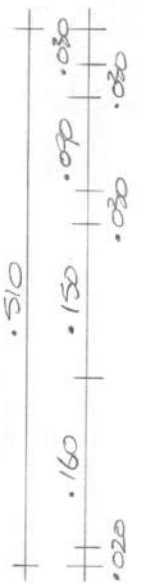
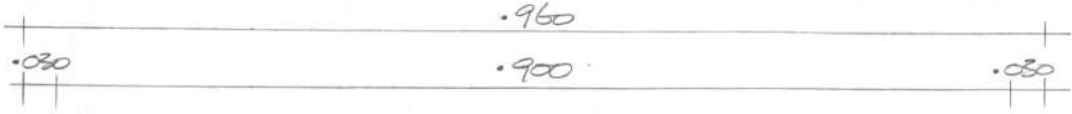

open shelf.

Drawer opening on rebated finger pull

Straw handle (lost) in Carpet

FRONT ELEVATION

PROPOSAL - PAIR OF
BEDSIDE CABINETS
FOR MASTER BEDROOM
BUTE.



1:5 JAN '91.

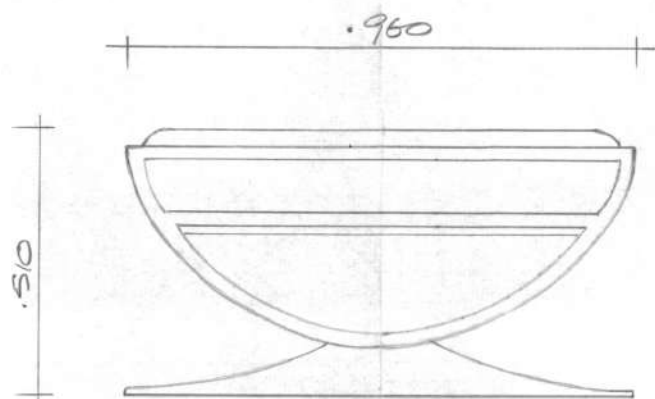

FRONT ELEVATION

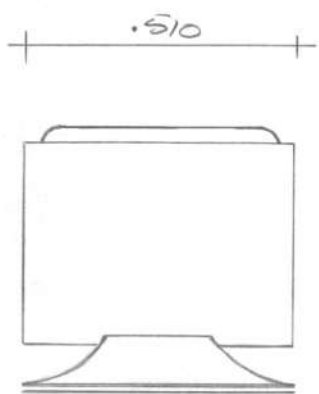

SIDE ELEVATION

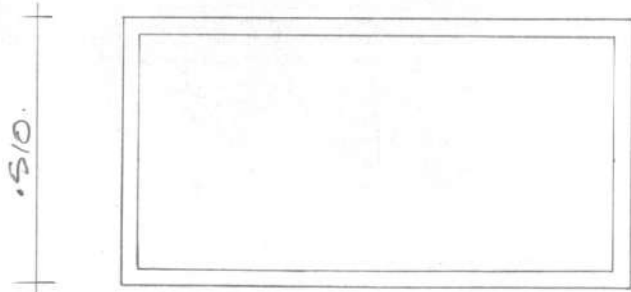

PLAN



PROPOSAL
BEDSIDE CABINETS
FOR
MASTER BEDROOM
BUTE

1:10 JAN'91

Suggest recess face drawers to contain depth handle but follow line curve.

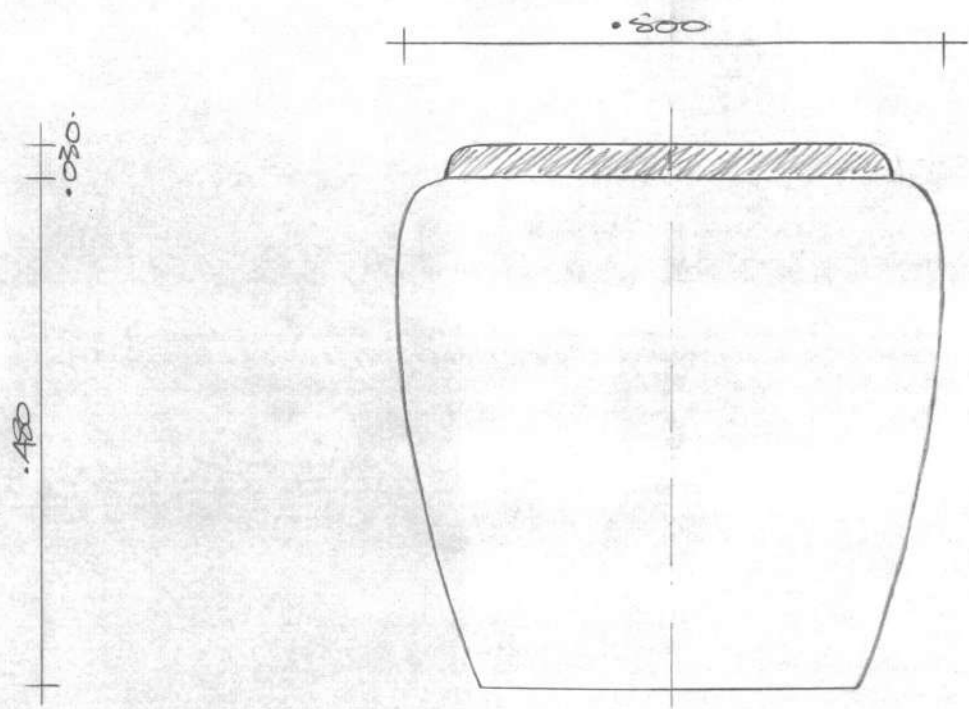

Side Elevation (Preferred Alternative)

PROPOSAL - PAIR OF BEDSIDE CABINETS FOR MASTER BEDROOM BUTE



1:5 Jan '91.

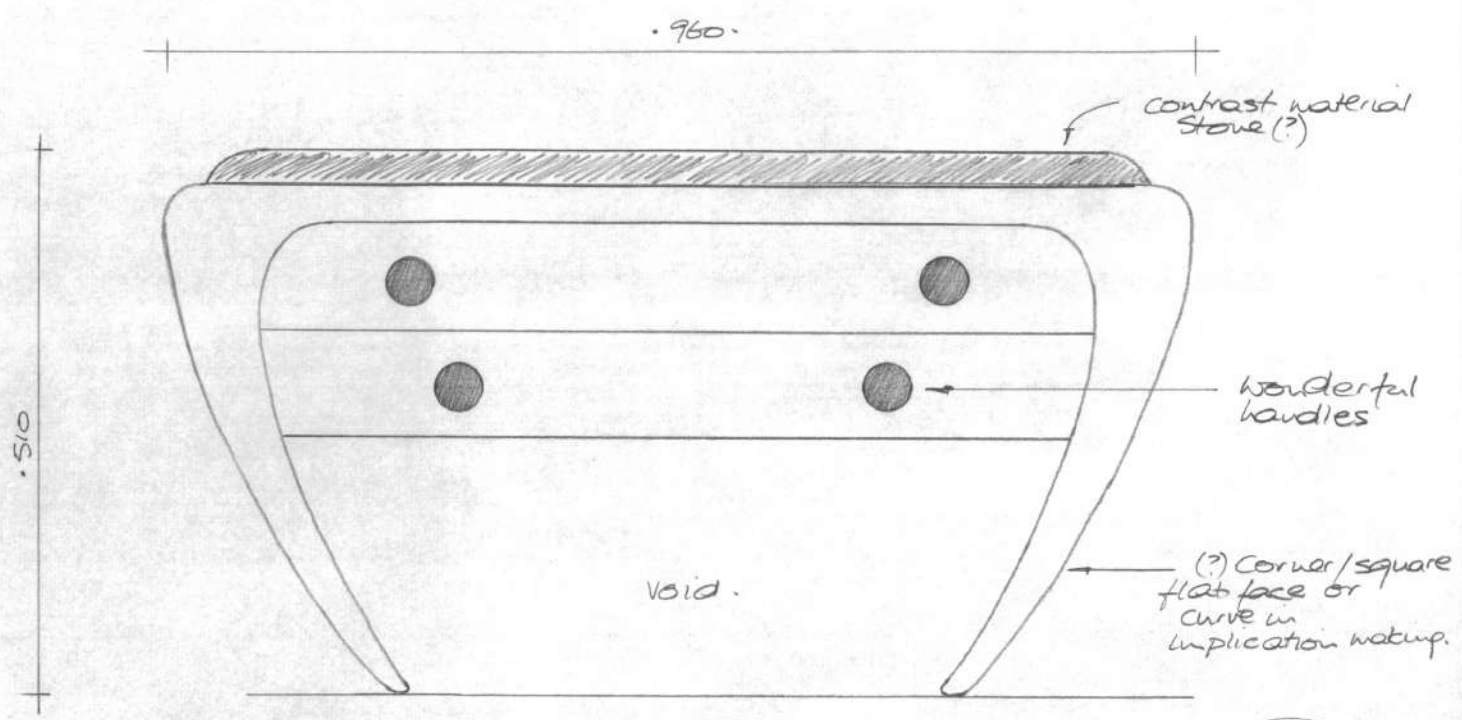

2 Drawers / Void Under

PROPOSAL - PAIR OF BEDSIDE CABINETS FOR MASTER BED ROOM BUTE.



1:5 Jan '91

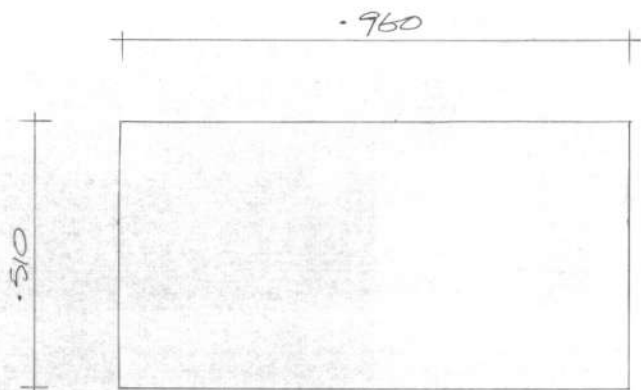

FRONT ELEVATION

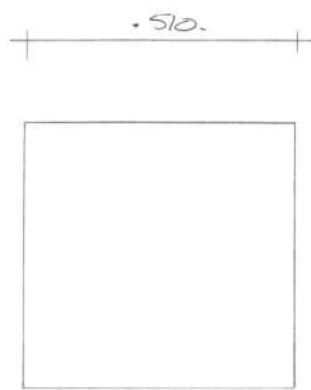

SIDE ELEVATION

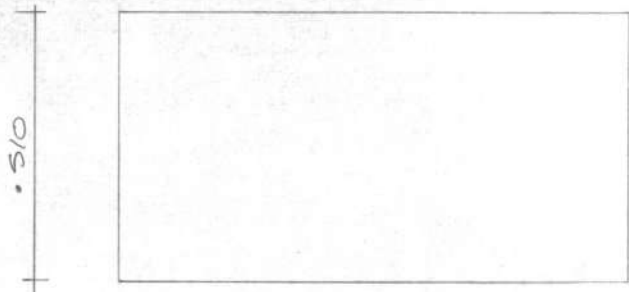

PLAN



OPTIMUM SIZE
PROPOSED BEDSIDE
CABINETS FOR
MASTER BEDROOM
BUTE

1:10 JAN '91

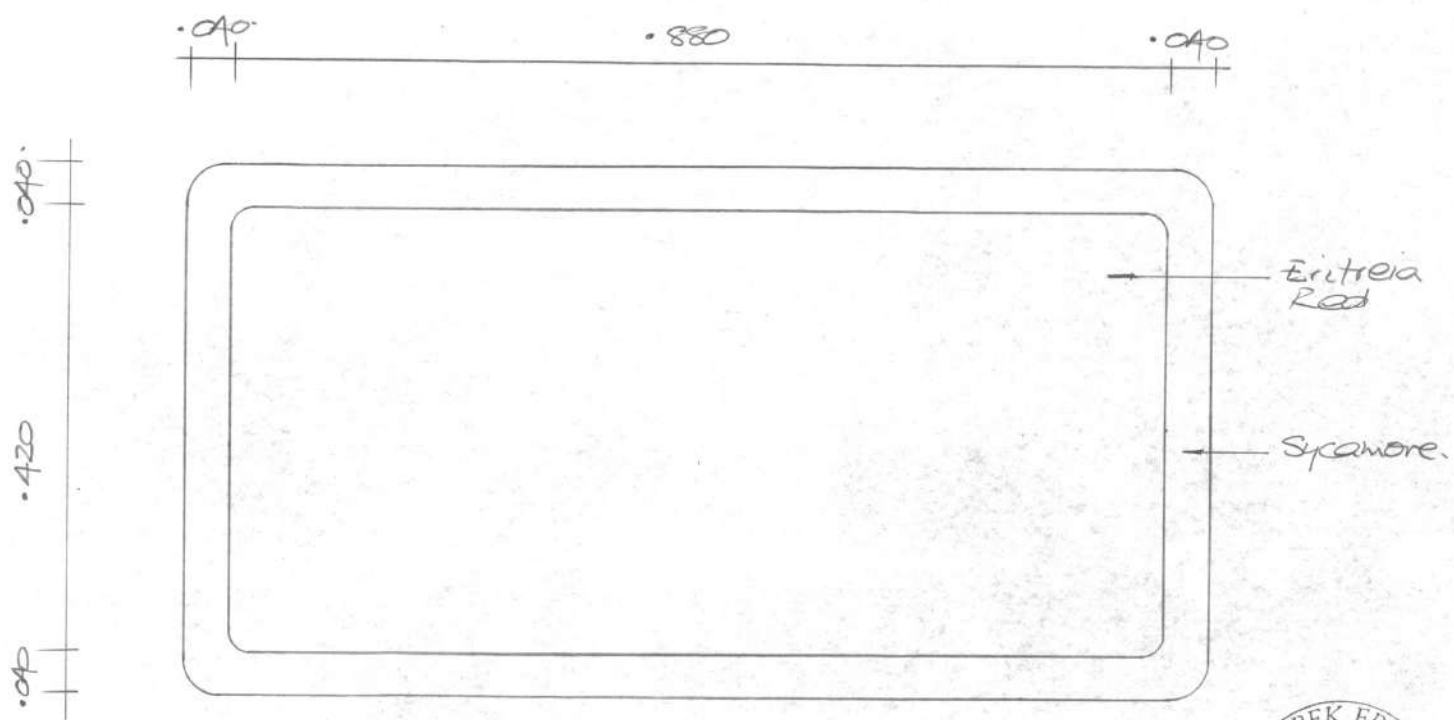

PLAN
PAIR OF BEDSIDE CABINETS
FOR MASTER BED ROOM
BUTE.



1:5 JULY 191.

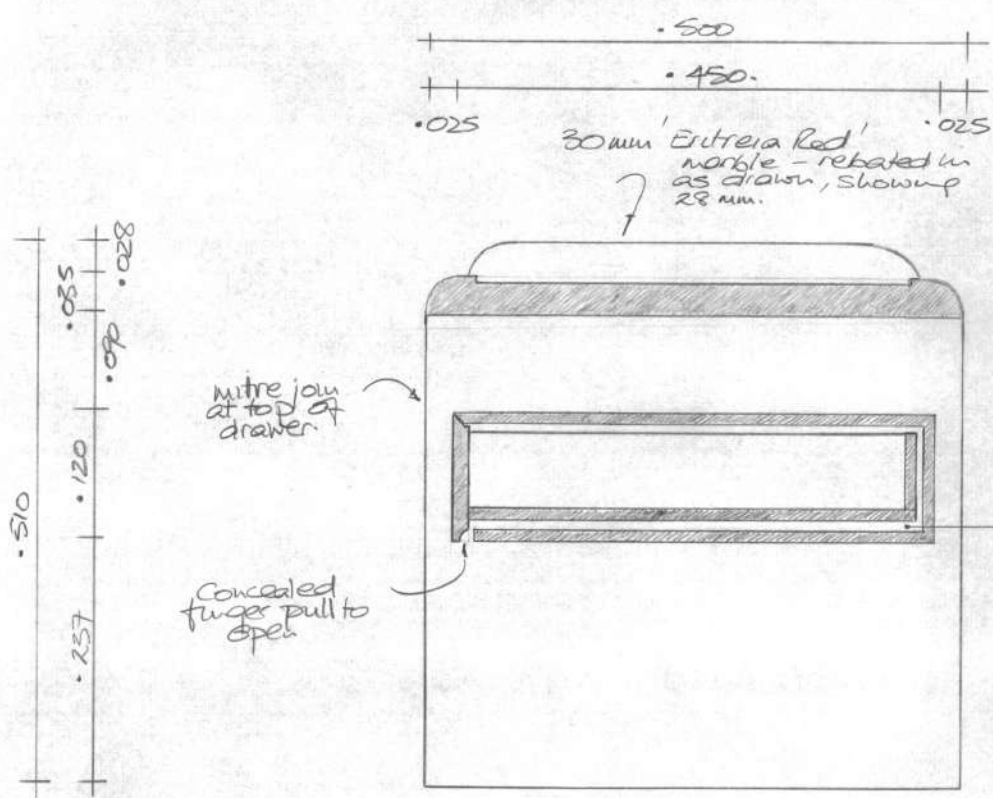

Kleowex Tissue box
 315 x 165 x 085 high
 Void height in drawer .075 m to fit above

Void to house concealed runners mounted under draw to ensure lightest running.

SECTION

PROPOSAL - PAIR OF BEDSIDE CABINETS FOR MASTER BEDROOM BUTE.



1:5 Feb '91.

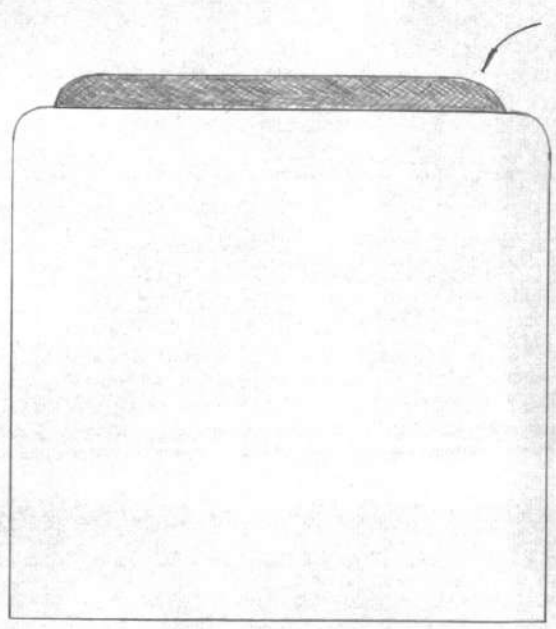
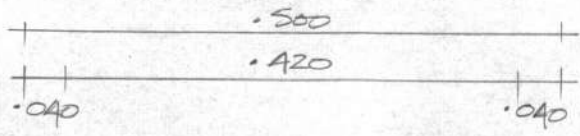

Eritreia Red
Polished Shownup
28 mm.

END ELEVATION

PROPOSAL - PAIR OF BEDSIDE
CABINETS
FOR MASTER BEDROOM
BUTE.



1:5 Feb '91

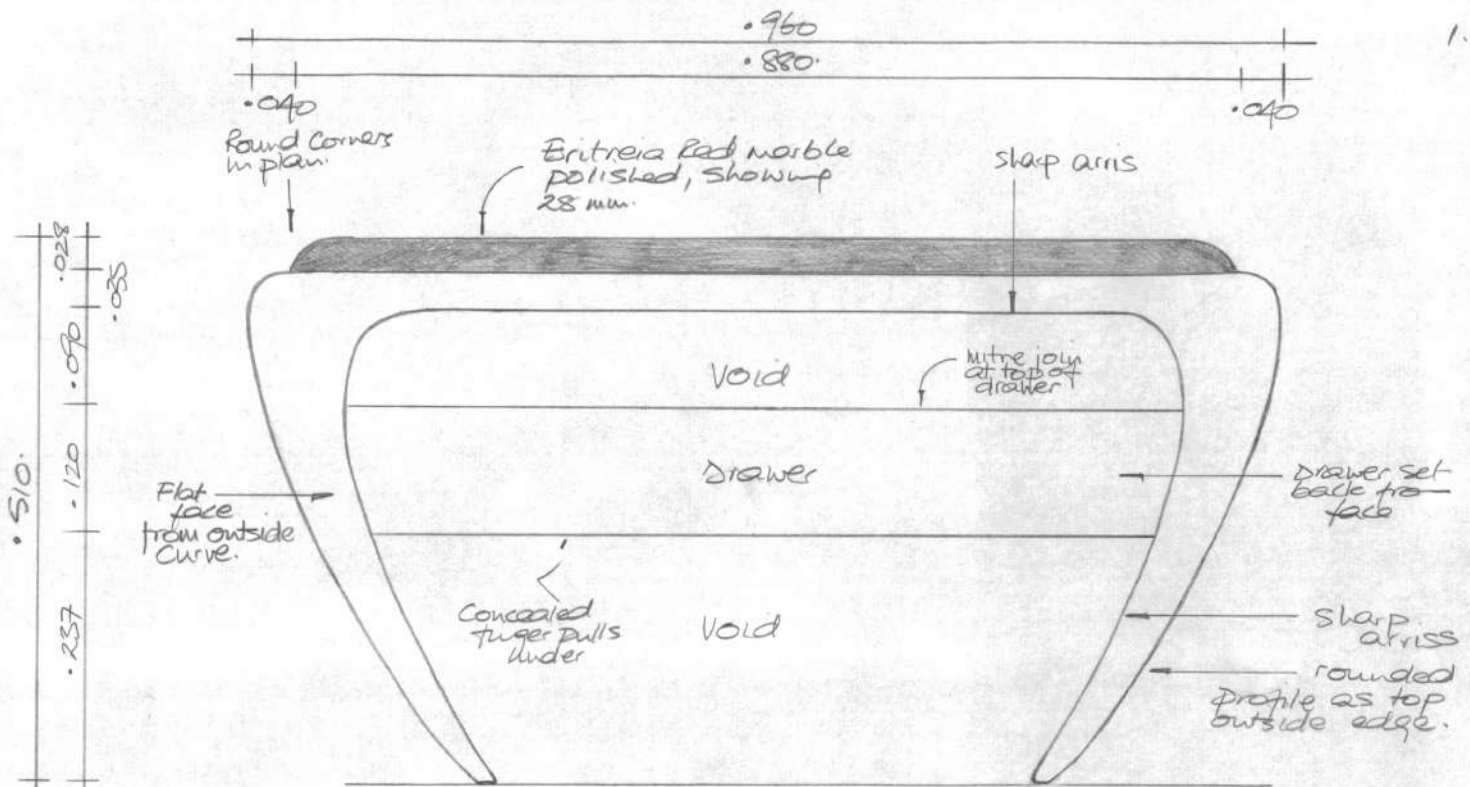

FRONT ELEVATION

PROPOSAL - PAIR OF BEDSIDE
 CABINETS
 FOR MASTER BEDROOM
 BUTE



1:5 Feb '91.



DO

Draper

Console

London

Showing work of drawer.

5.

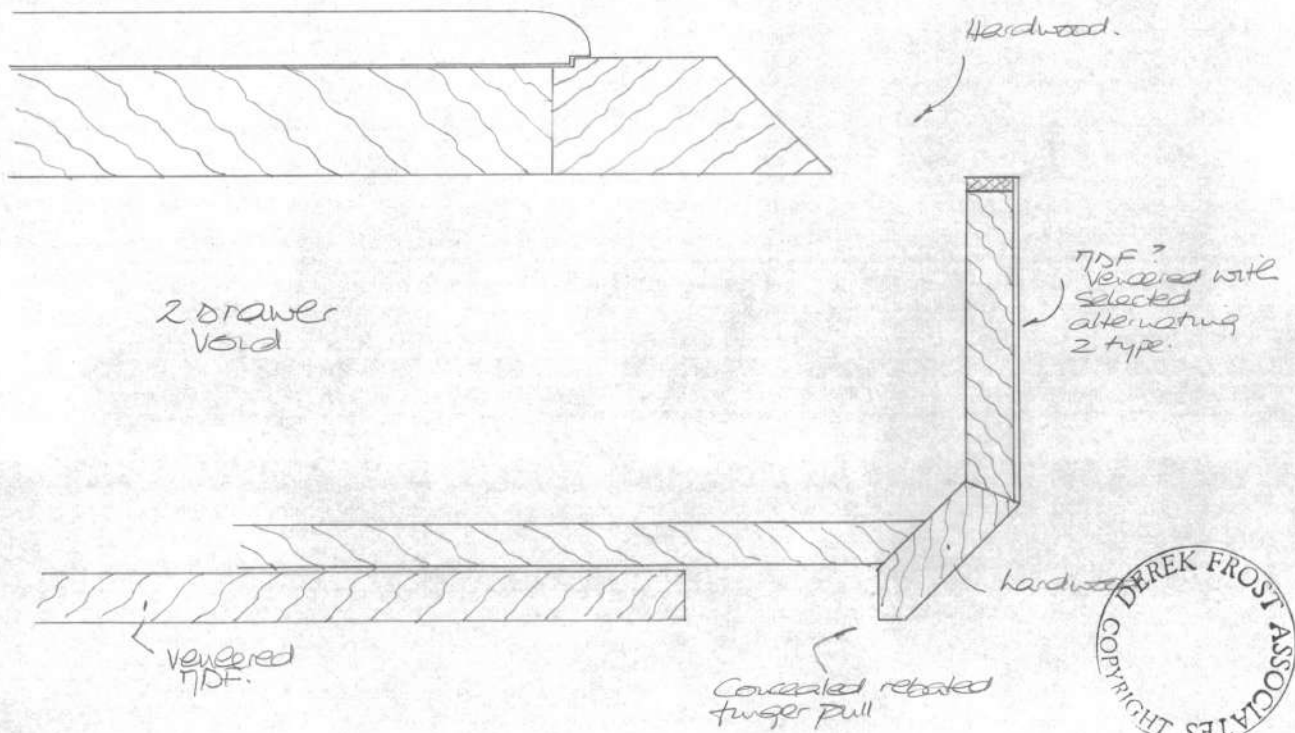

SECTION - CANTILEVERED CONSOLE
ENTRANCE HALL - BOTE HOUSE

1:2
NOV '90.

Showup
Drawer Closed.

Nosed + shallow rebated
Polished
20mm St. Florient
Marble.

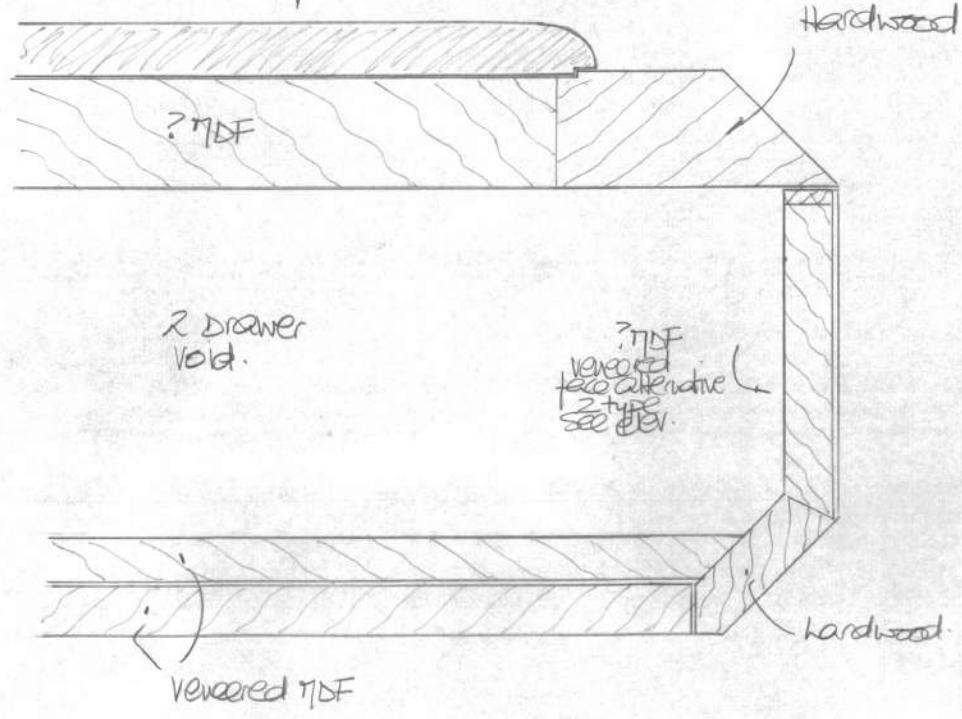

SECTION - CANTILEVERED CONSOLE
ENTRANCE HALL - BUTE HOUSE.

1:2
NOV 190

OPTION B.

3.

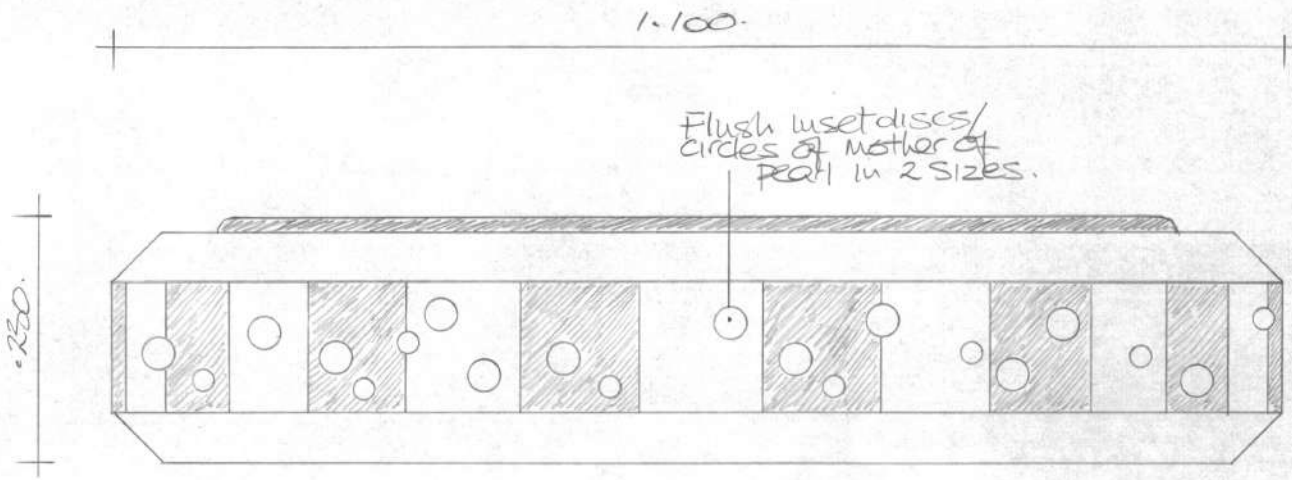

FRONT ELEVATION - CANTILEVERED
CONSOLE
E. HALL - BUTE HOUSE



1:5
NOV 190.

OPTION A.

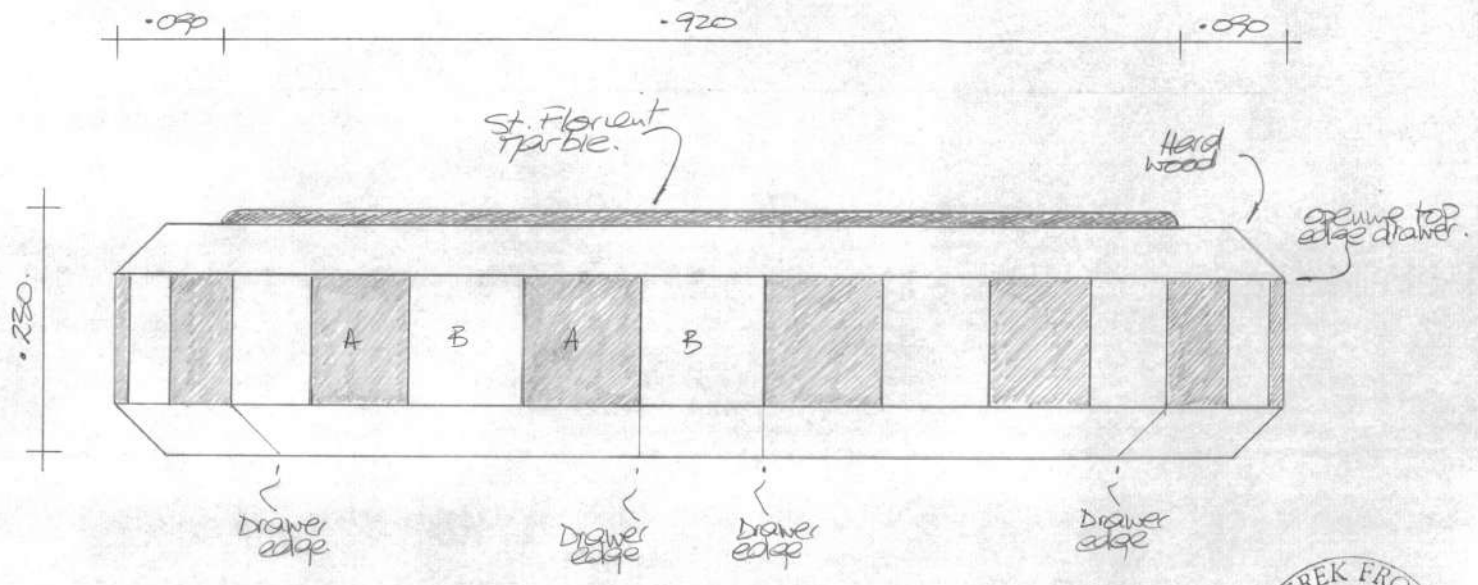

A + B - Alternating veneers applied to vertical face full perimeter
 - acting to disguise drawer line



FRONT ELEVATION - CANTILEVERED CONSOLE
 E. HALL - RUTE HOUSE

1:5
 NOV 190.



DQ

Draper

Horn Bed

Sussex, UK

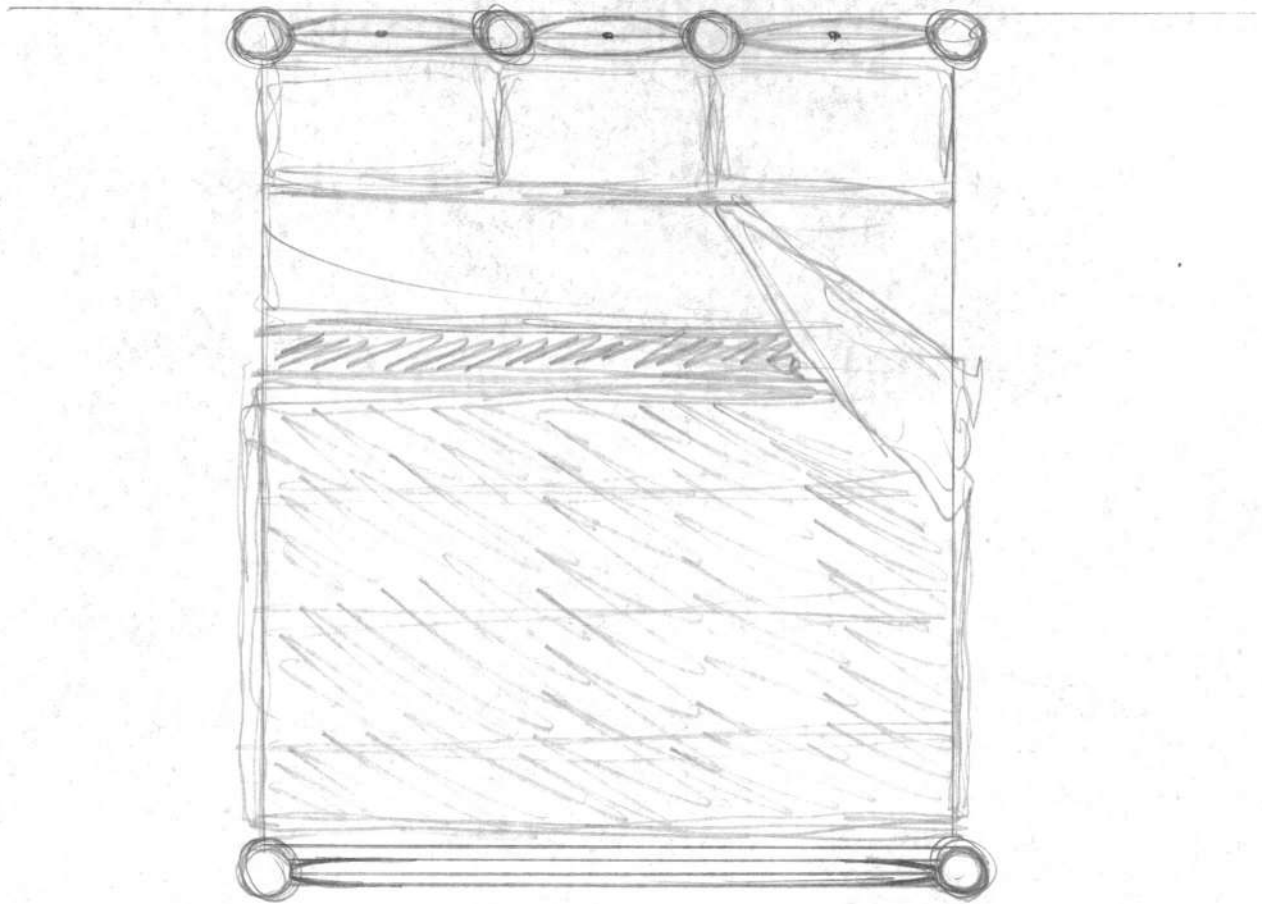

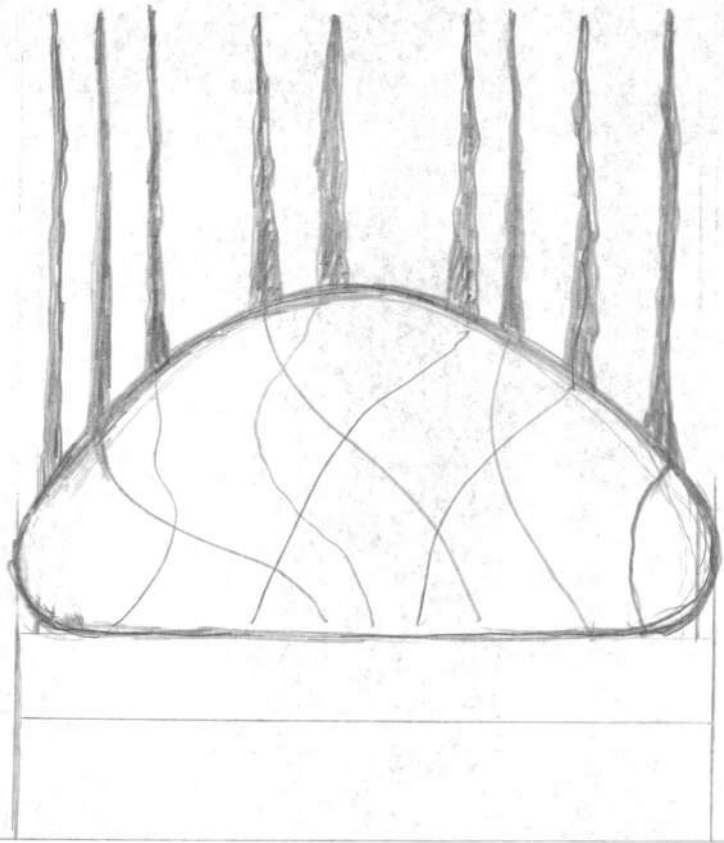

New Tack

Fret or inlay

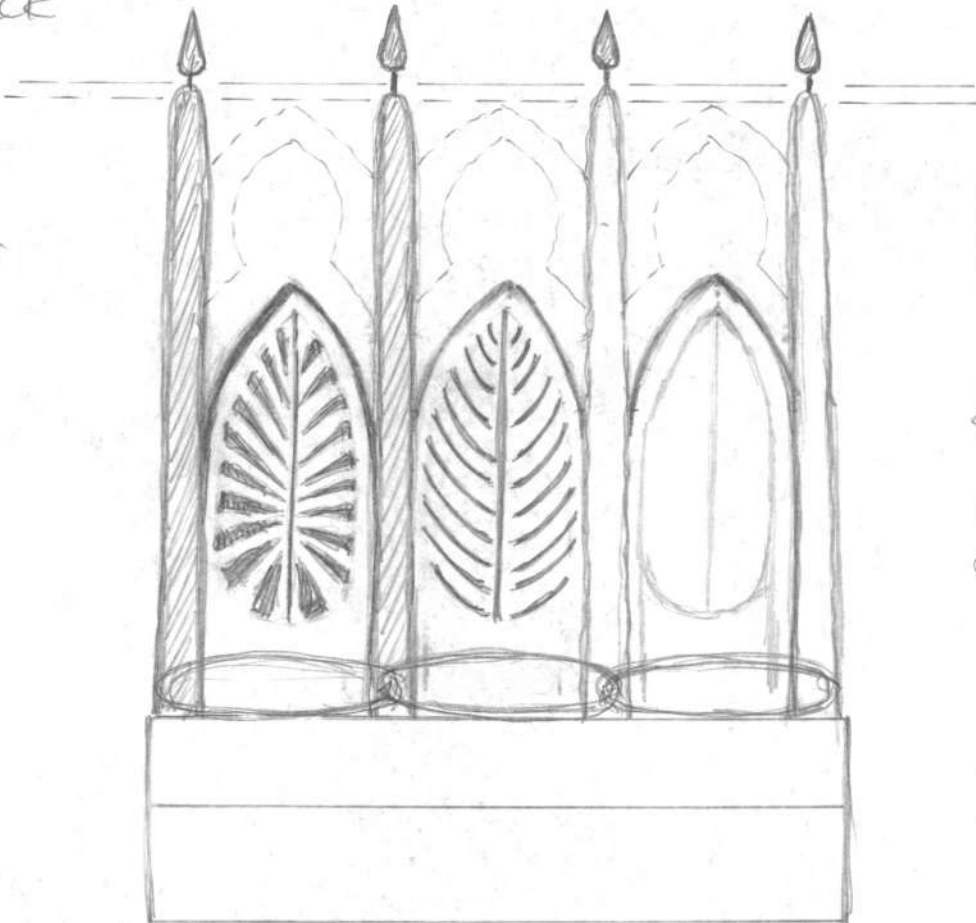

Indian
 Arab.
 Mogul
 Jaipur - like
 Stone Colour
 inlay.
 in wood (?)
 cc likes colour



abra
Africa
warrior
spear

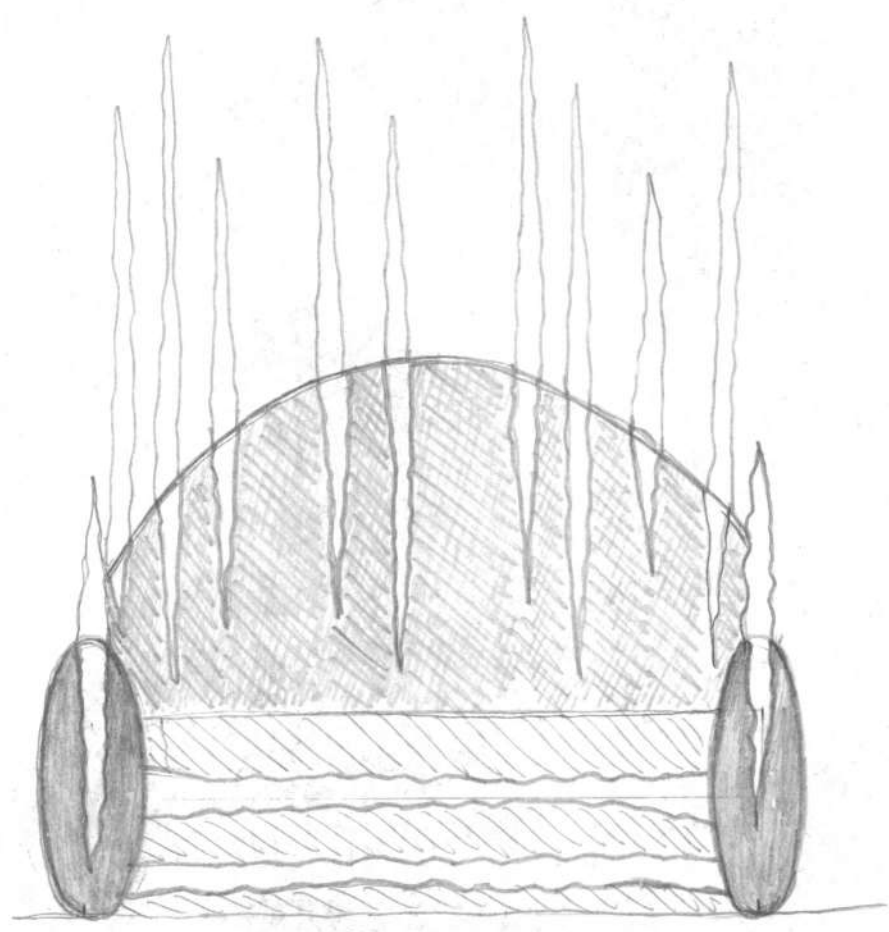
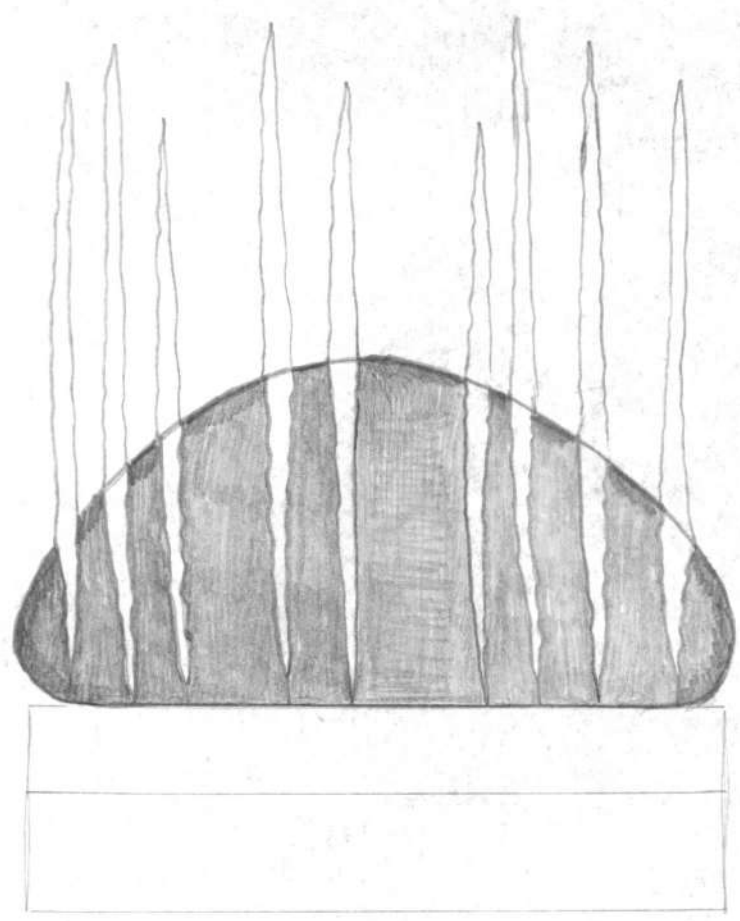

? patinated copper.
- curve outer edge moon.

//

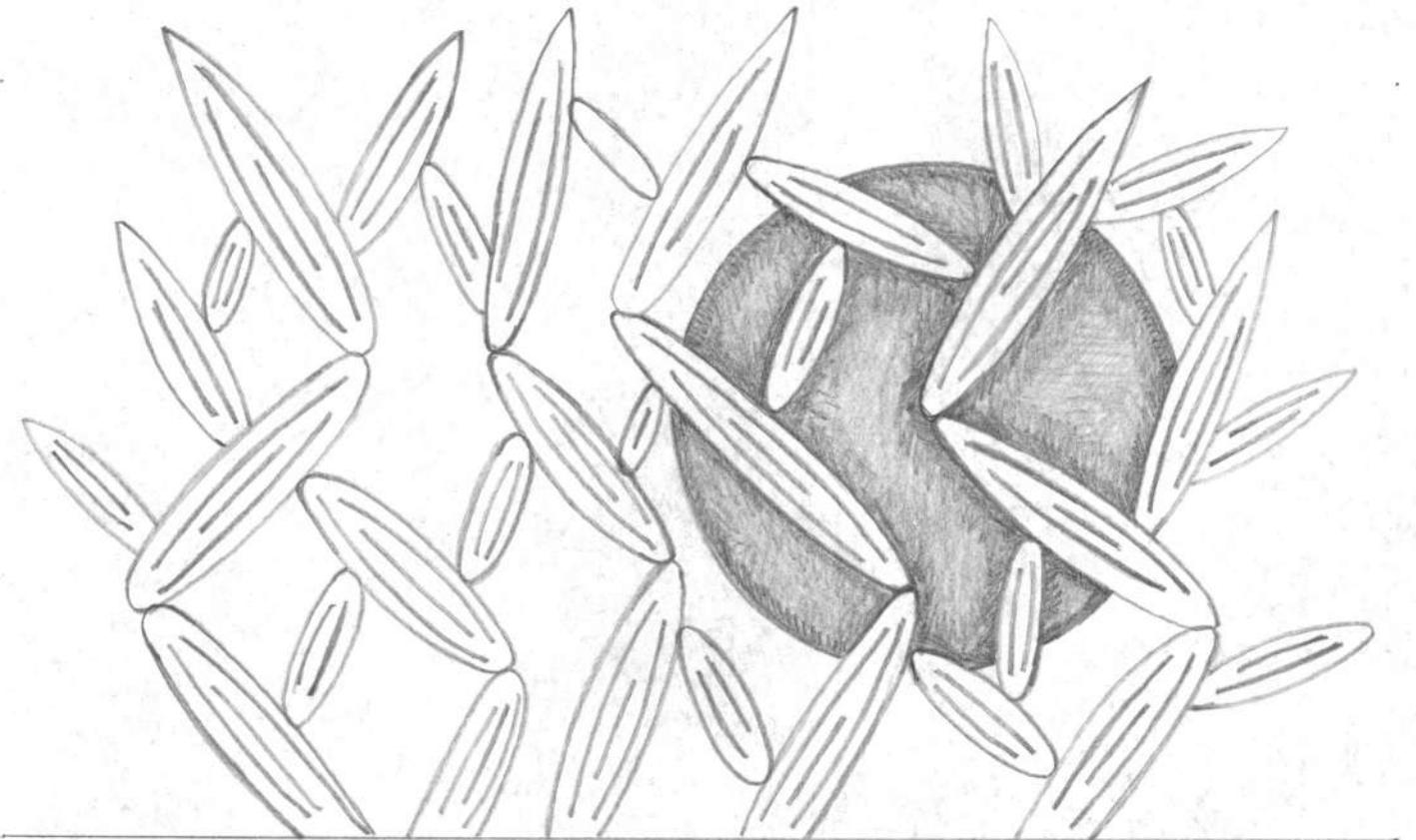
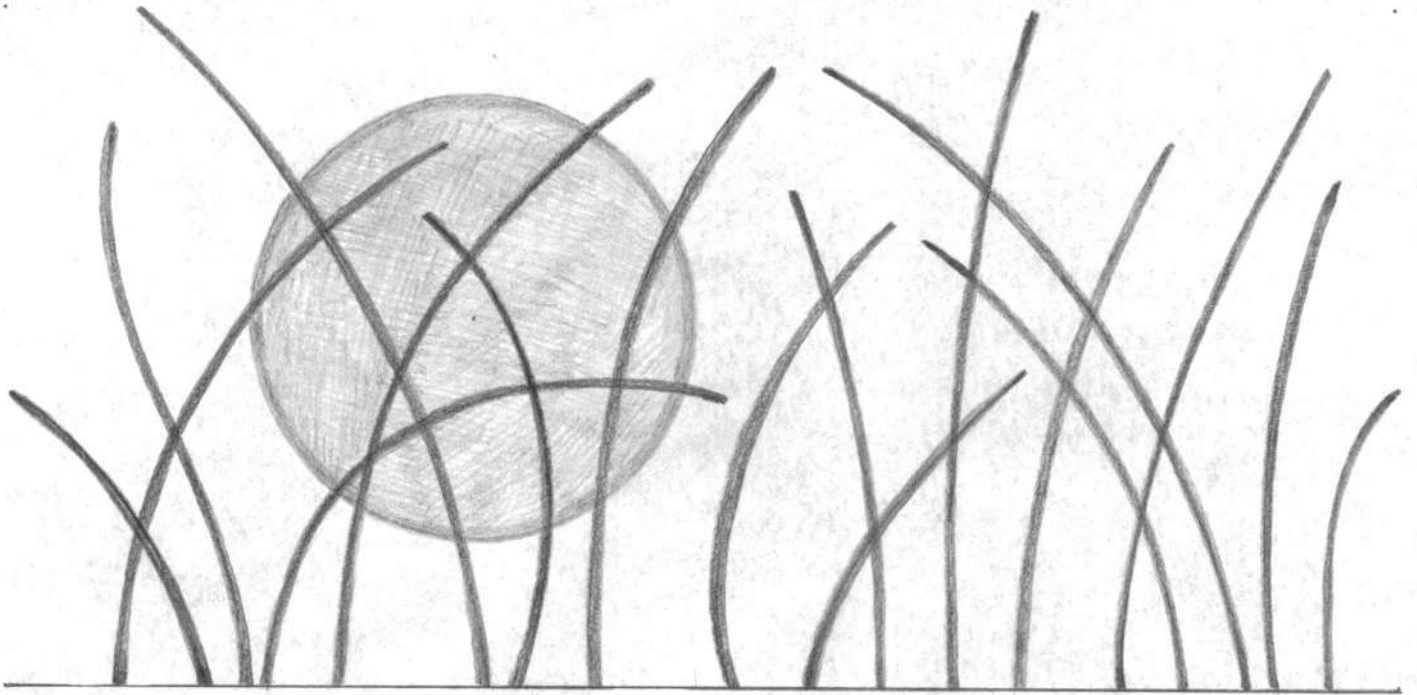

DEREK FROST ASSOCIATES
COPYRIGHT

161
01:1
161
01:1

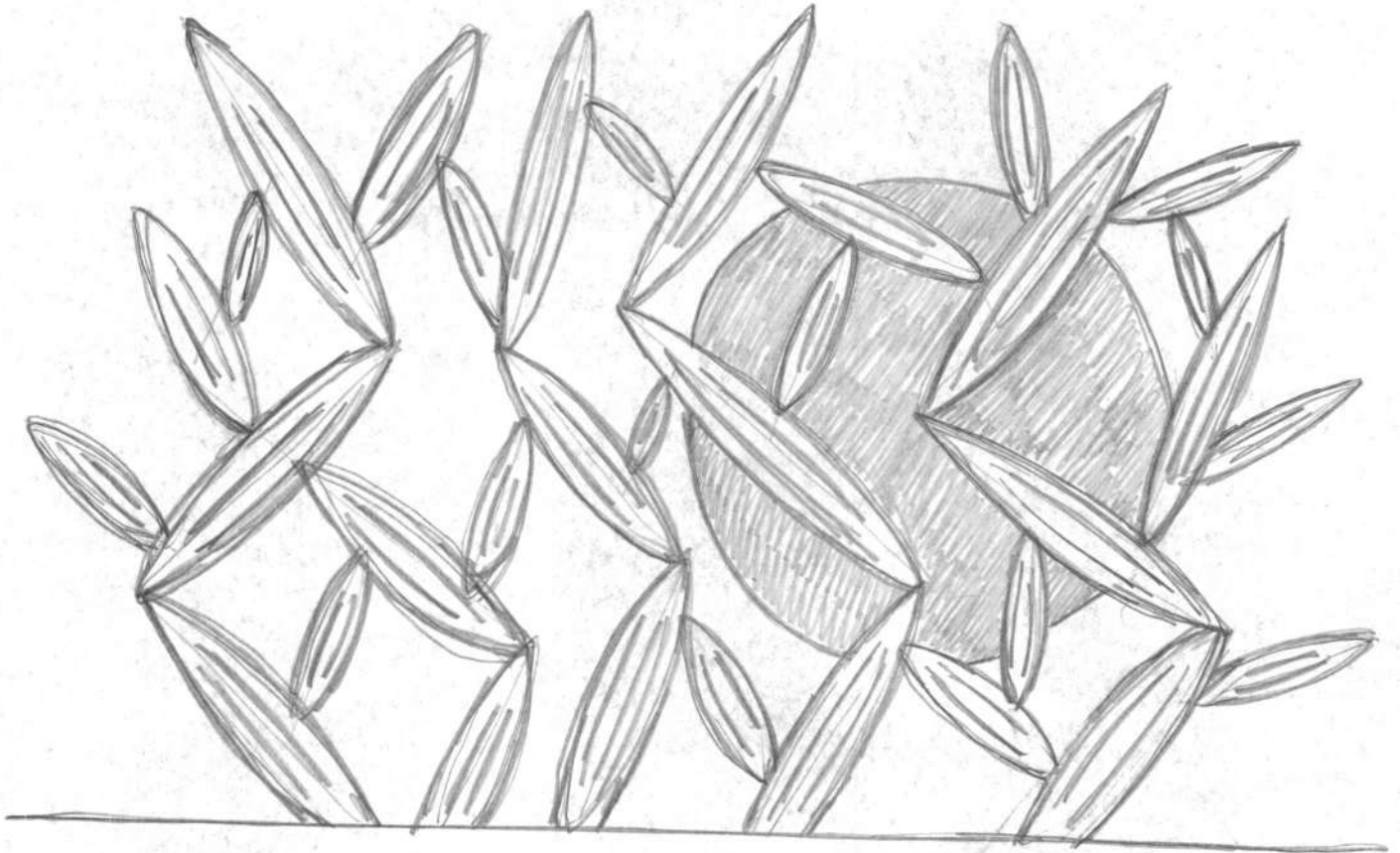

or cactus.



1.10
sept 1971

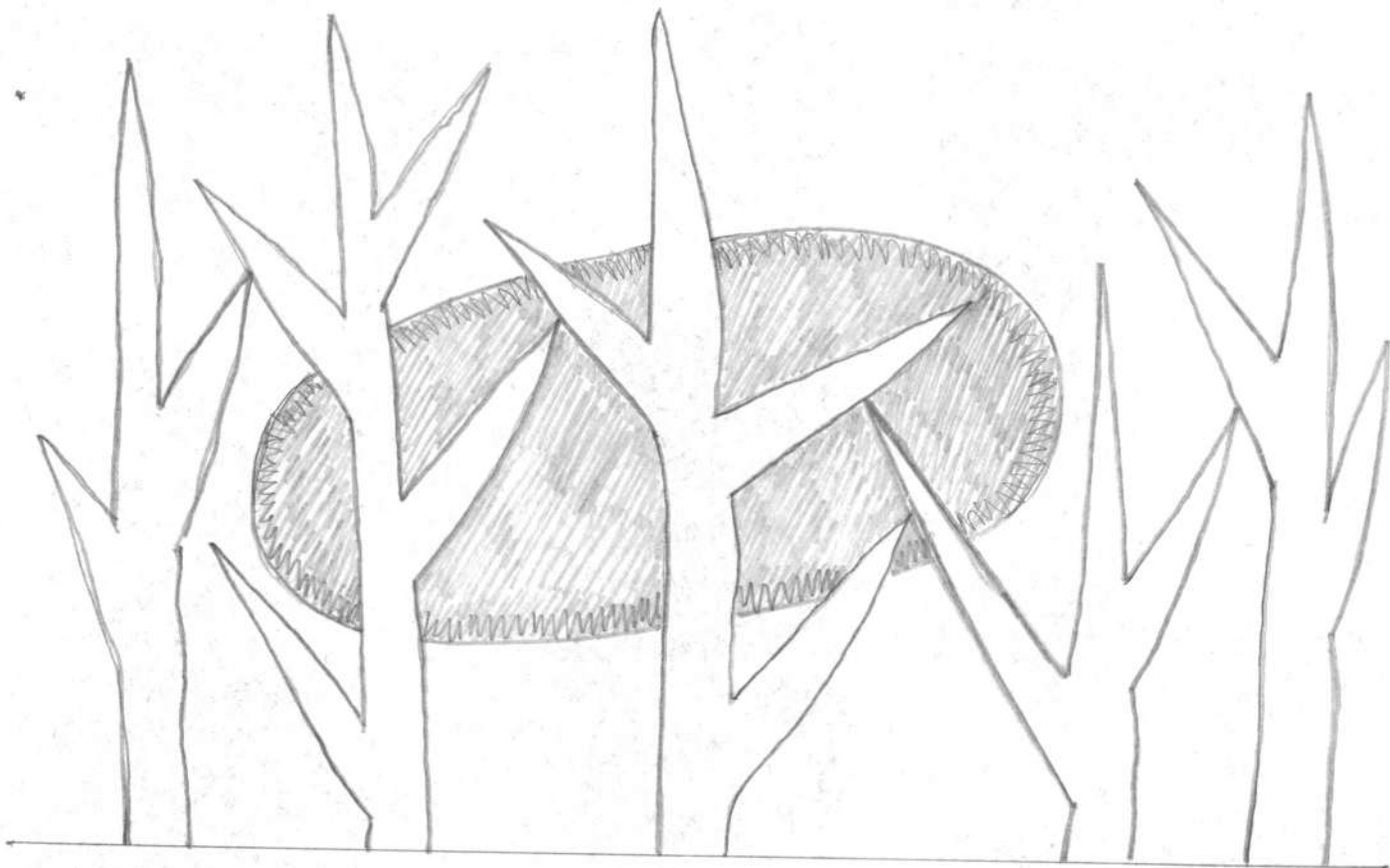
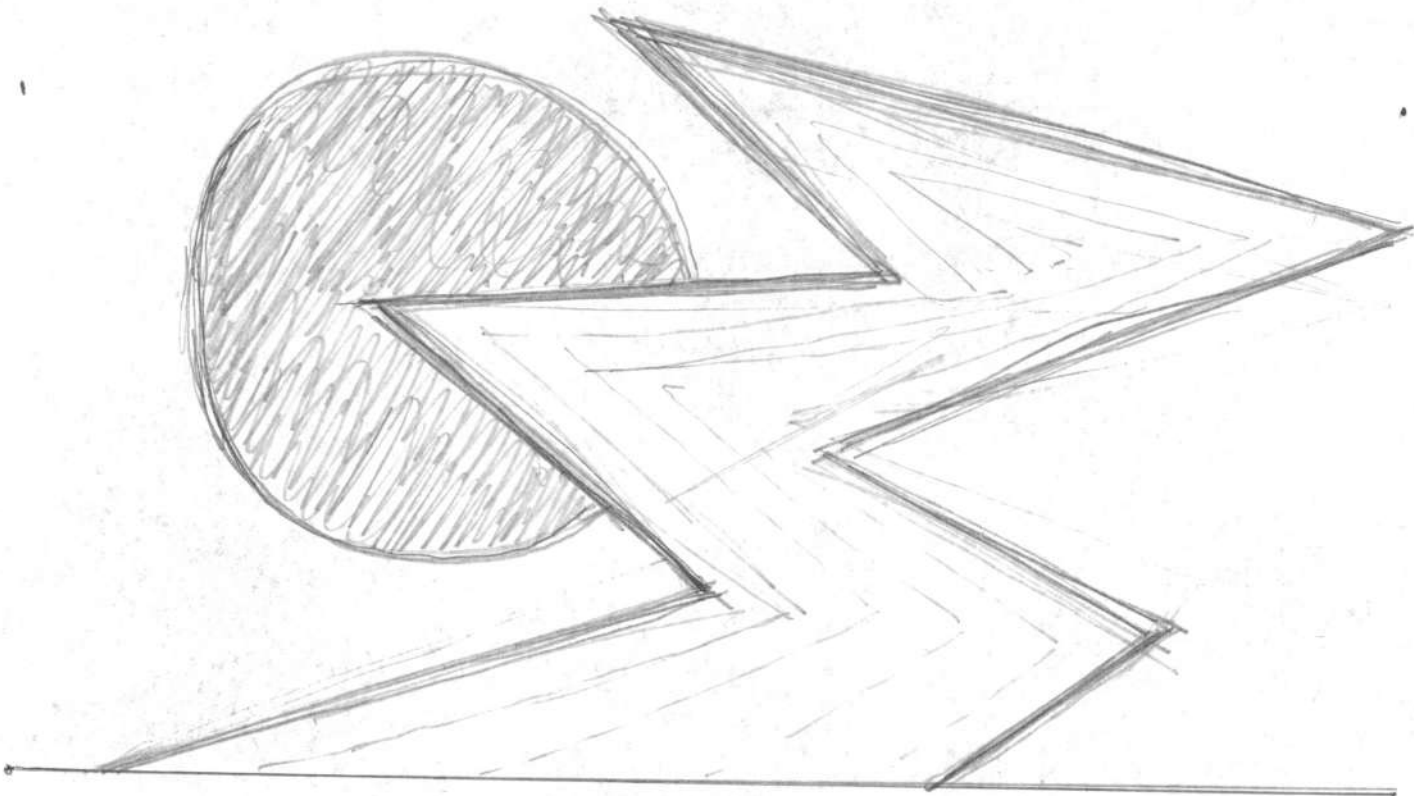

Coral



1:10
Sept 191

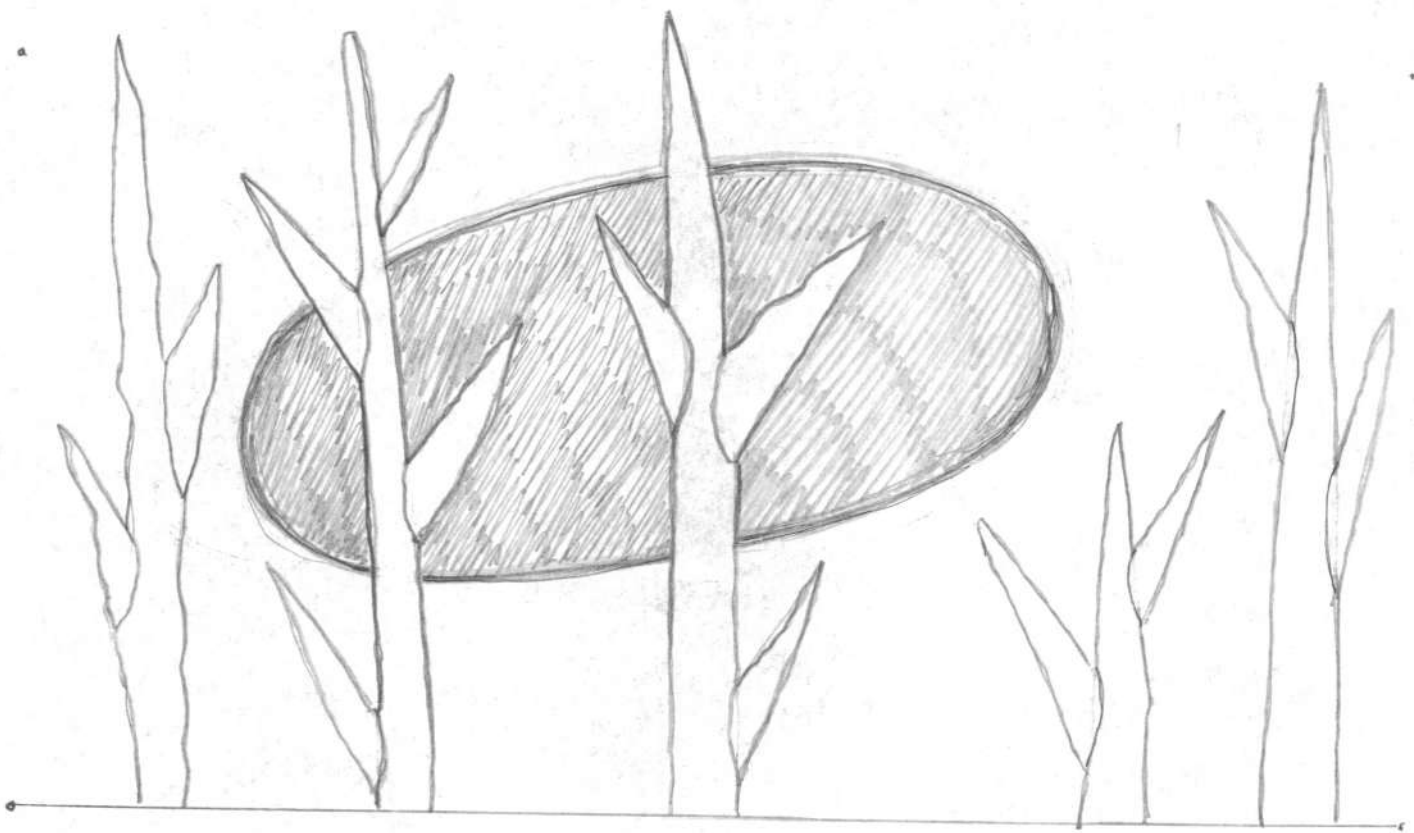
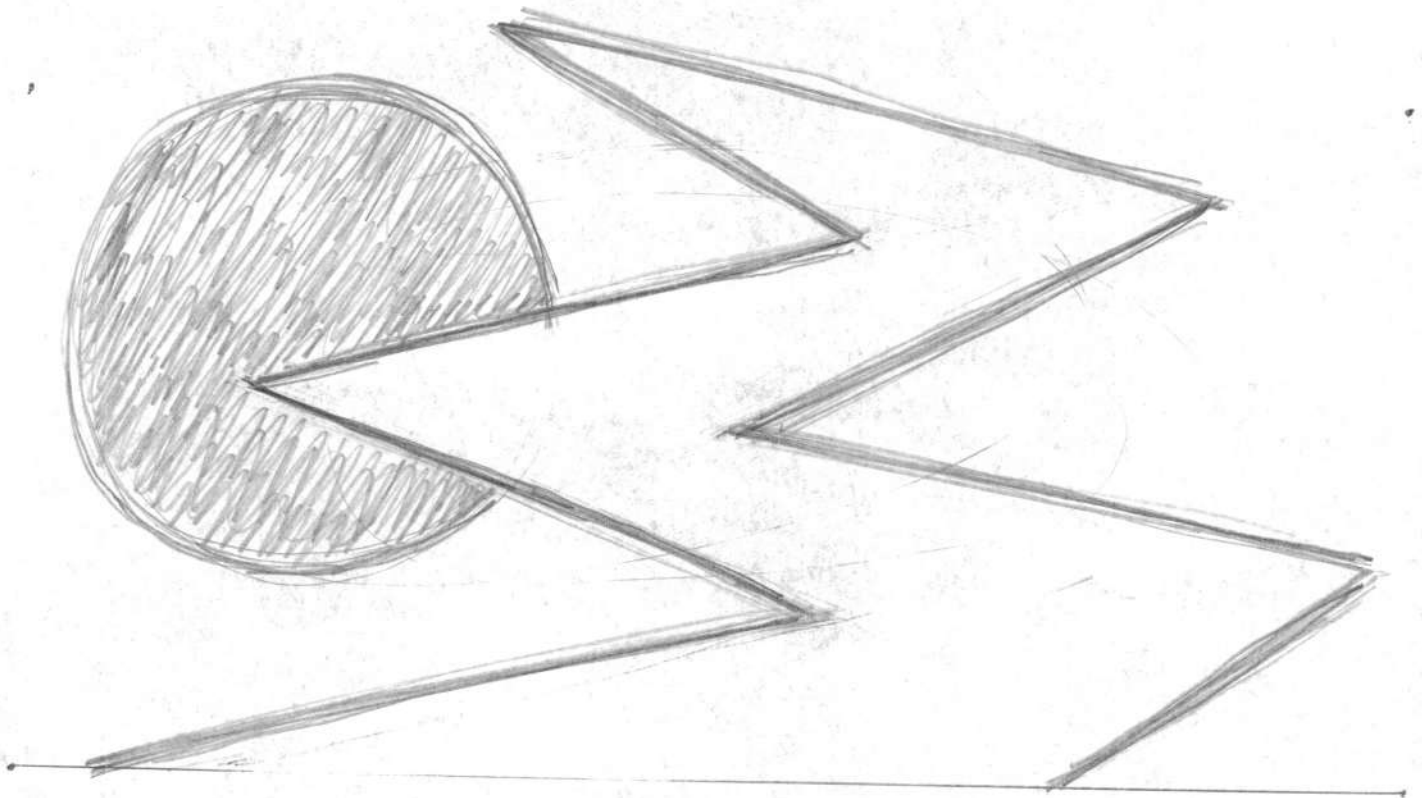

DEREK FROST ASSOCIATES
COPYRIGHT

1:10
Sept. 1991

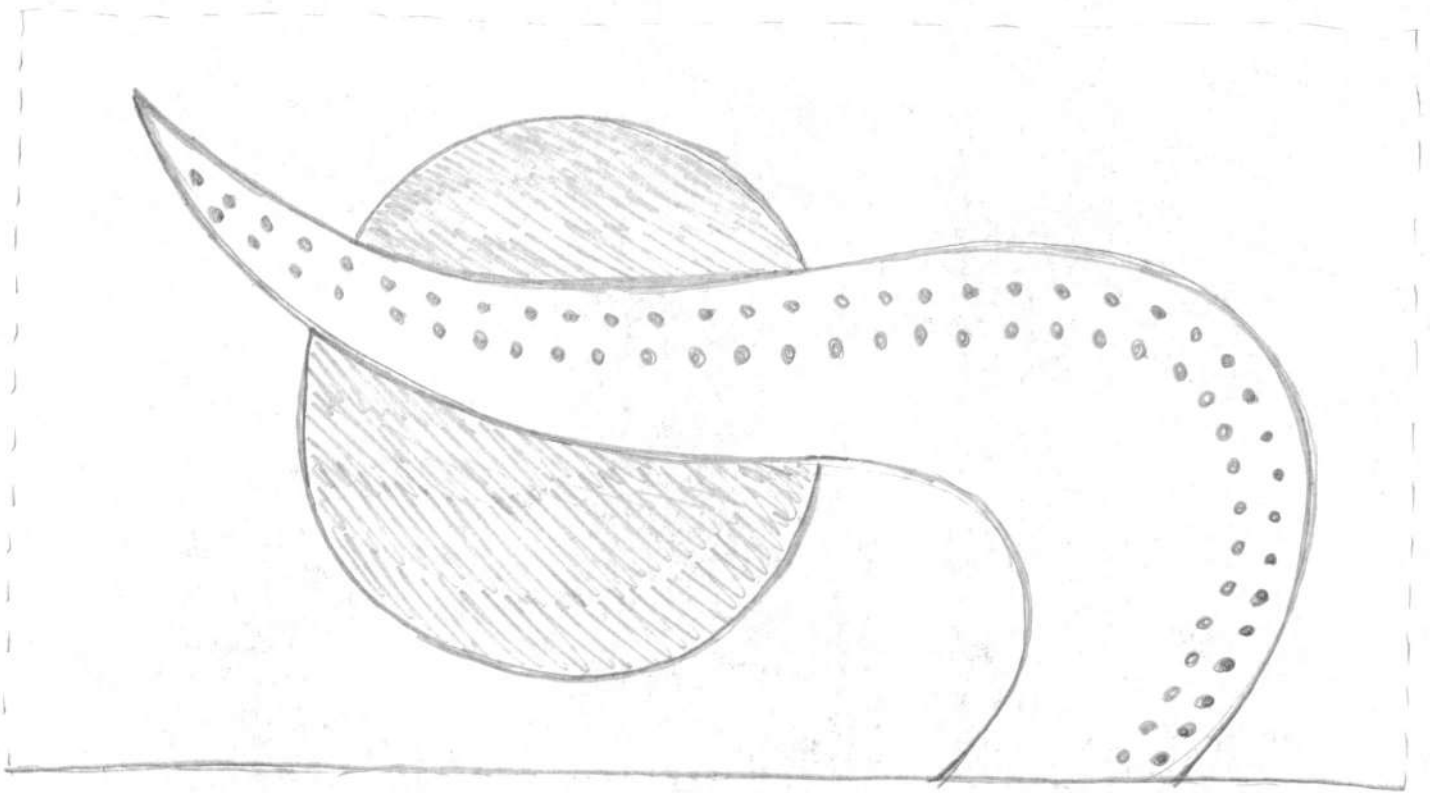
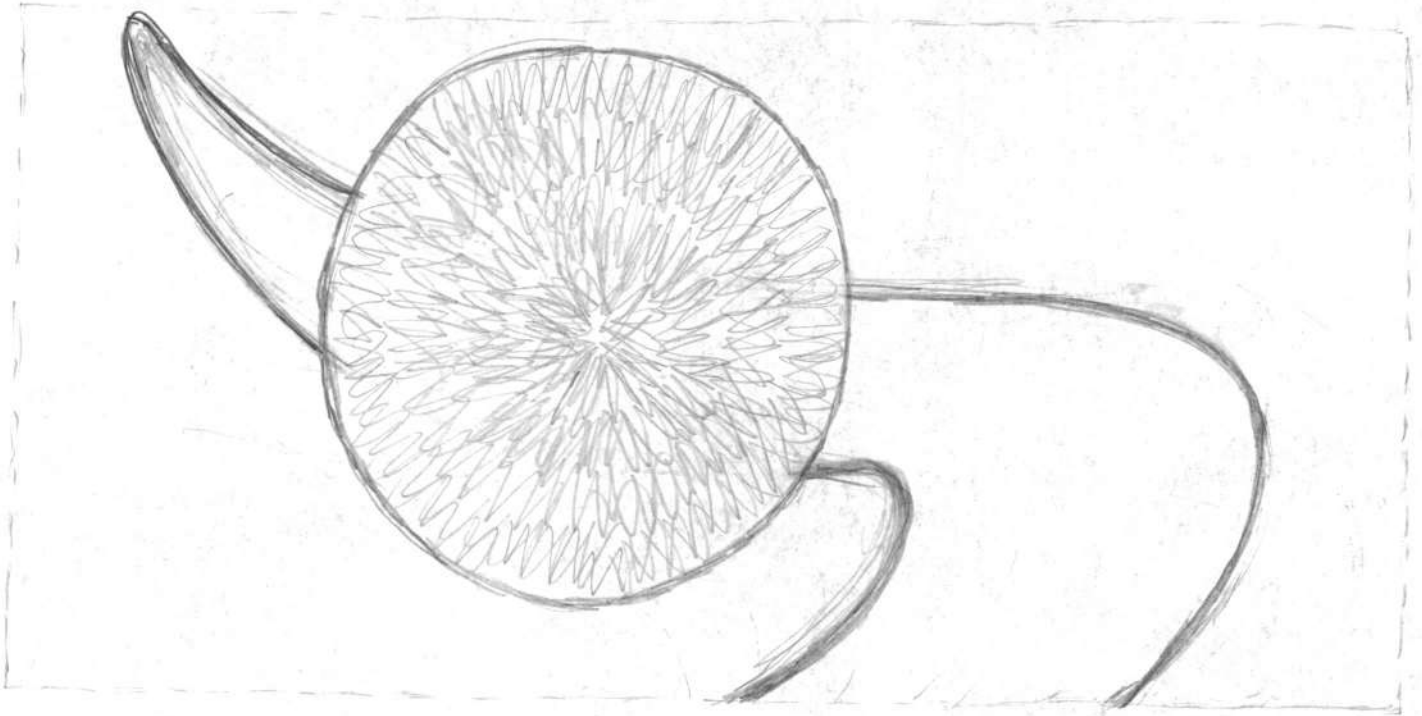

DEREK FROST ASSOCIATES
COPYRIGHT

1.10
sept '91

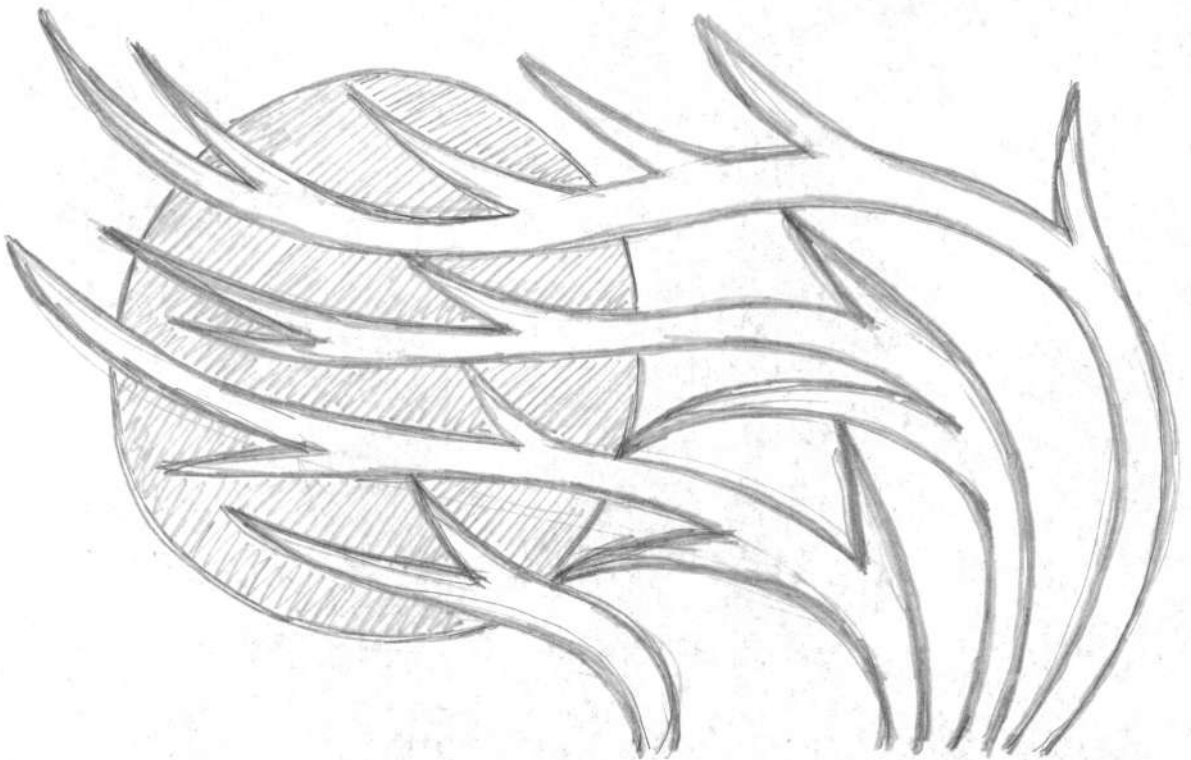
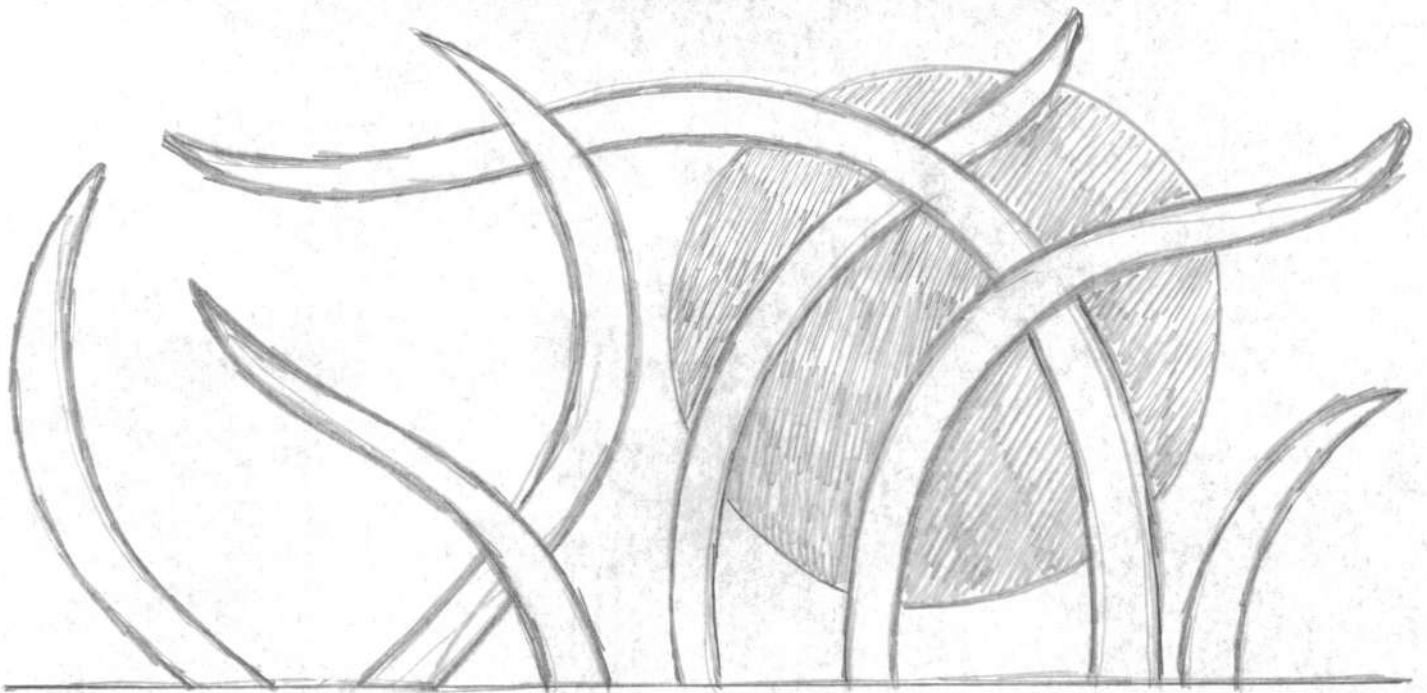

DEREK FROST ASSOCIATES
COPYRIGHT

1:10
Sept 1991

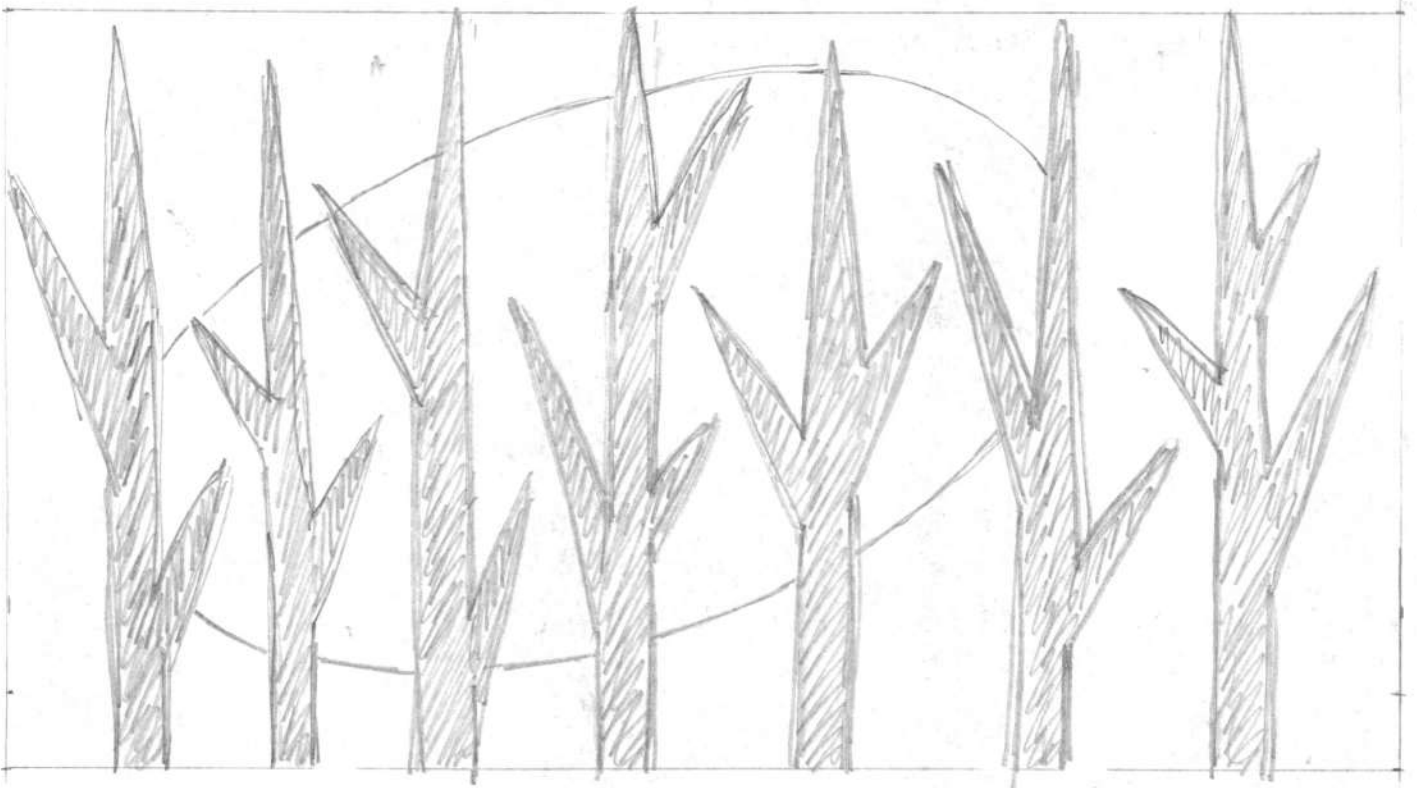
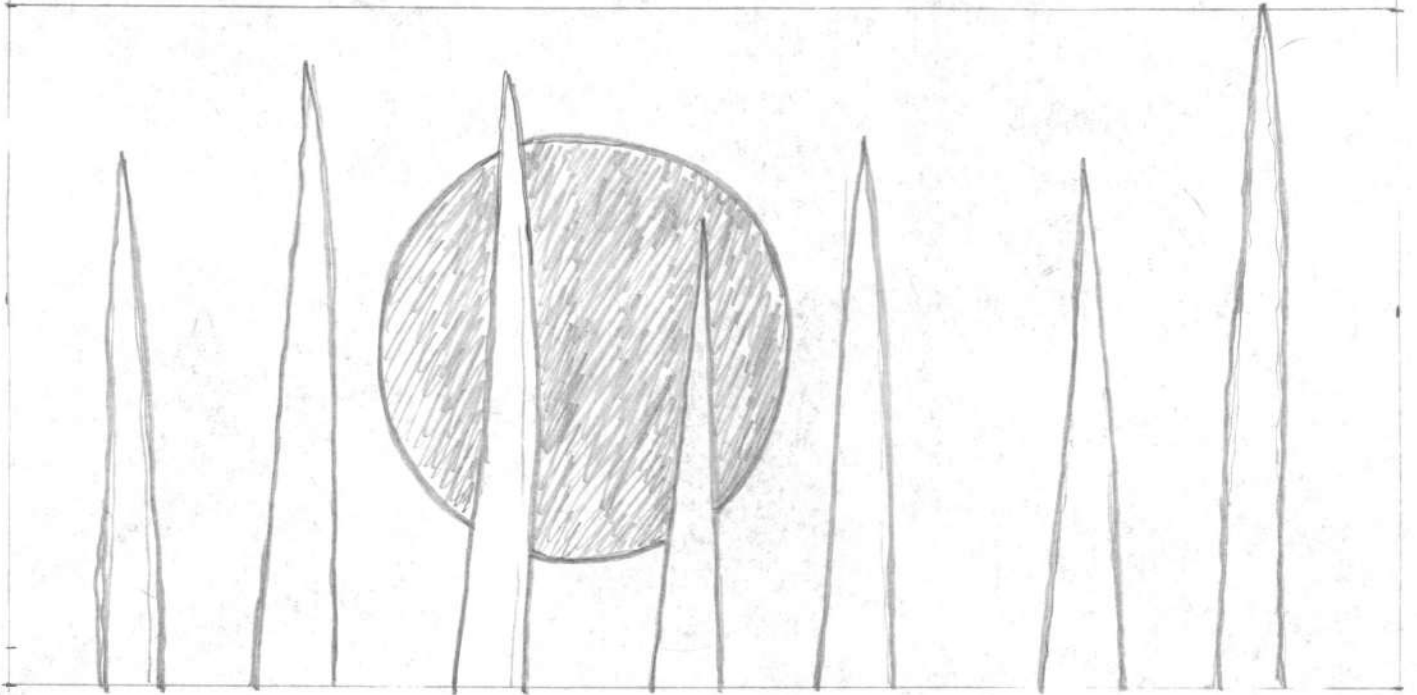

DEREK FROST ASSOCIATES
COPYRIGHT

19/10
Sept 91

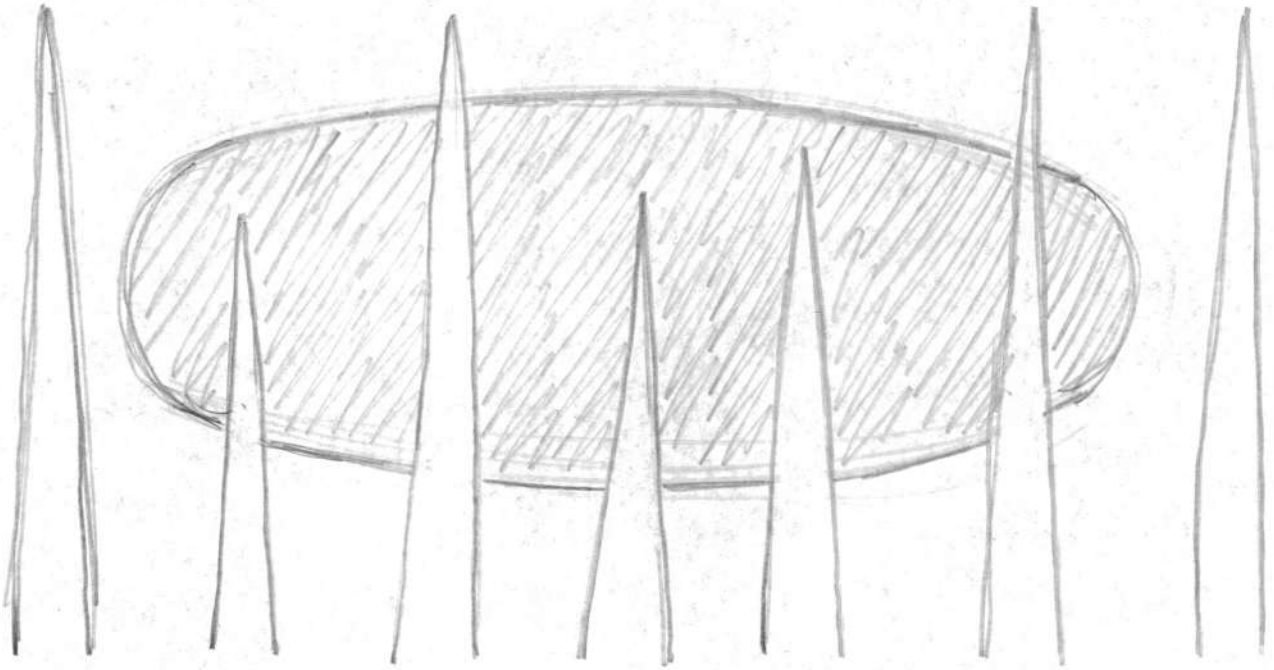

1:10
Sept 19

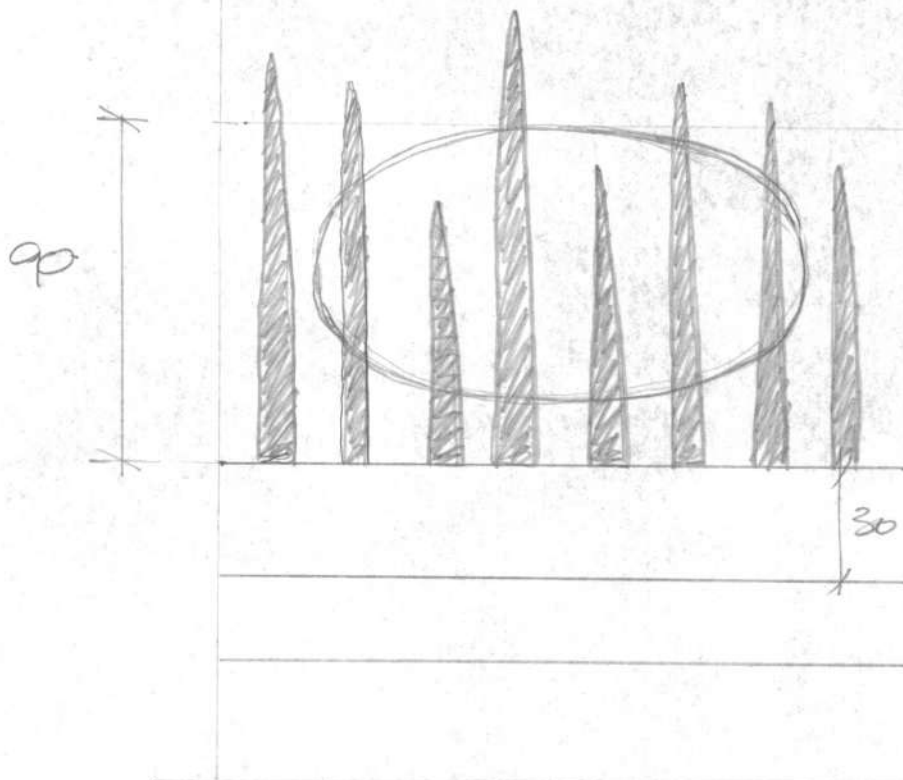

? Solid support behind pillows
Top of mattress

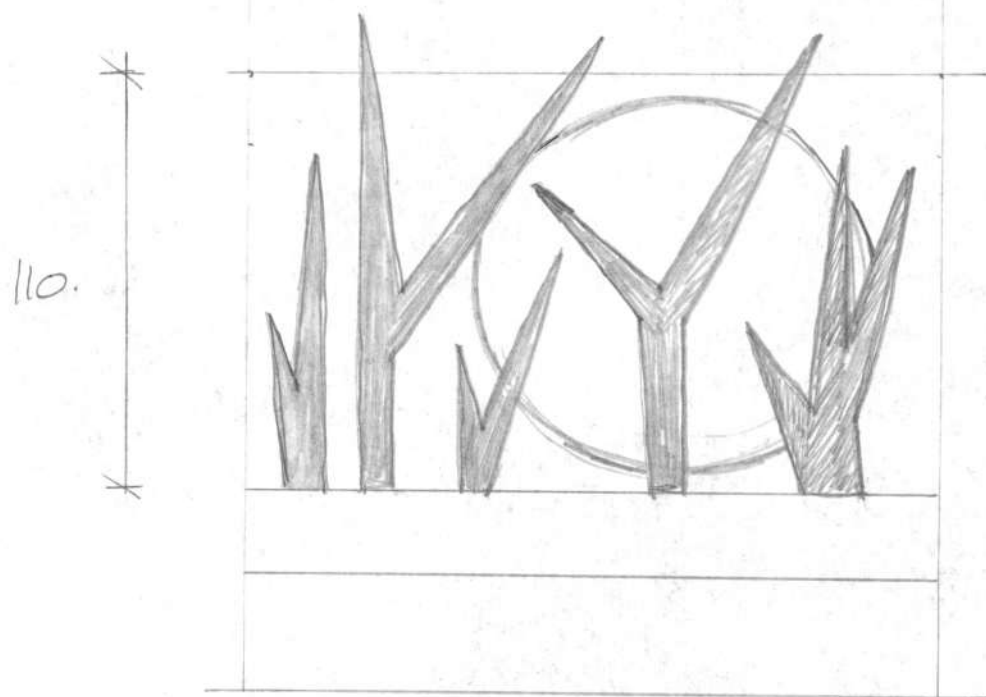

1.20
Sept '91

c2.

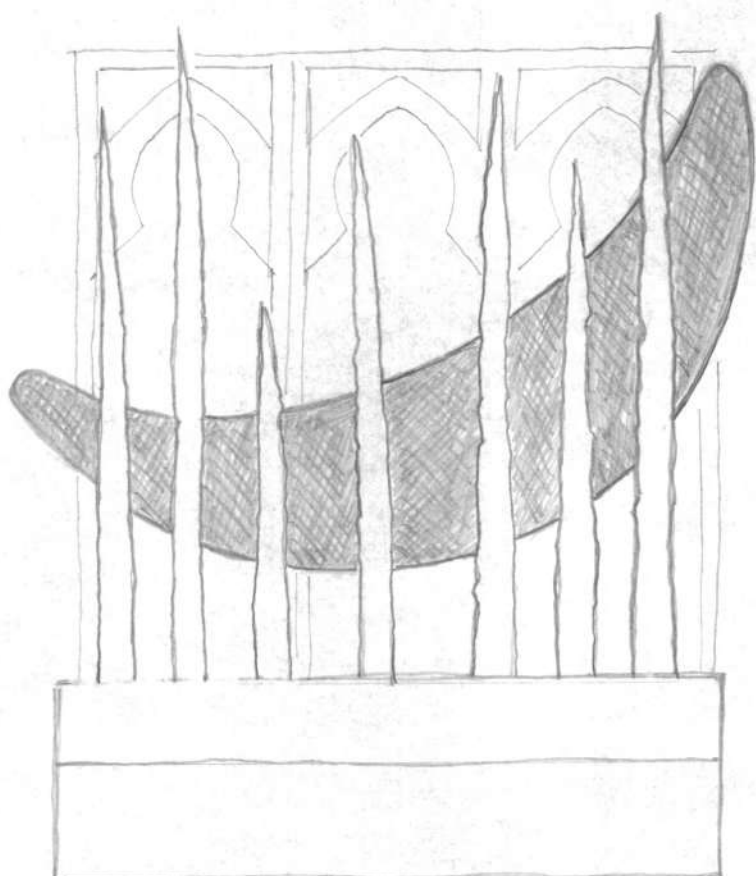
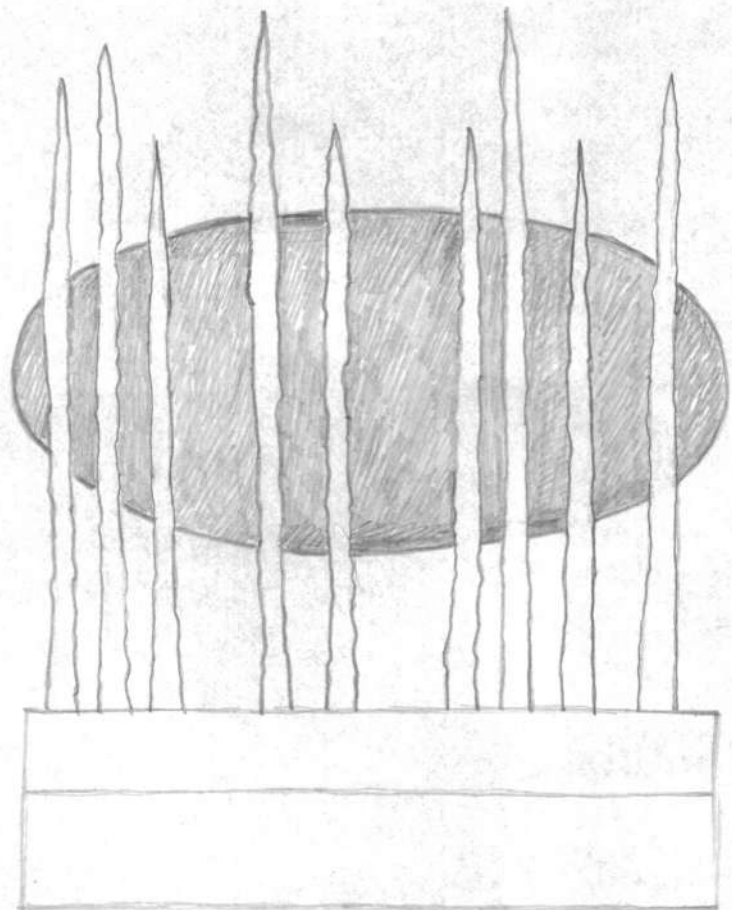

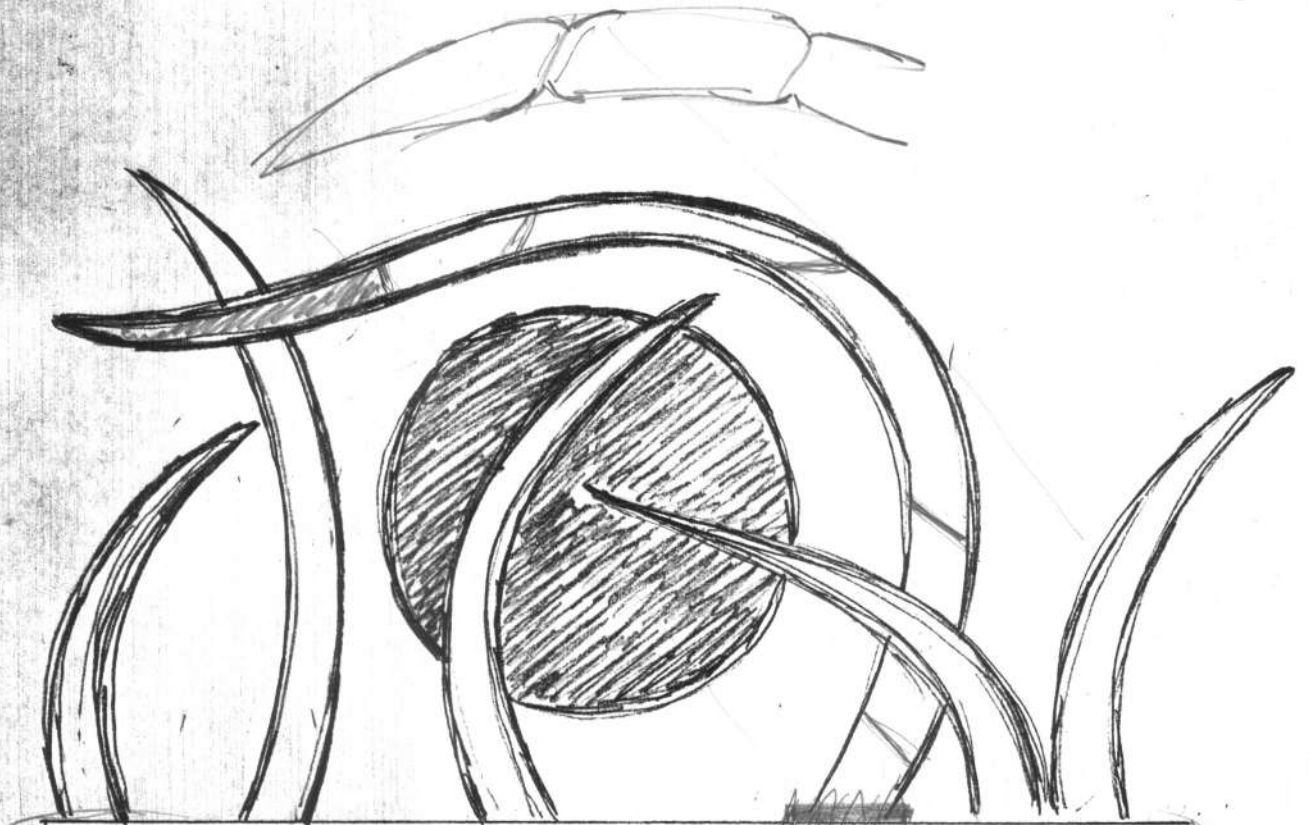

17/5
17/5
17/5

1/6

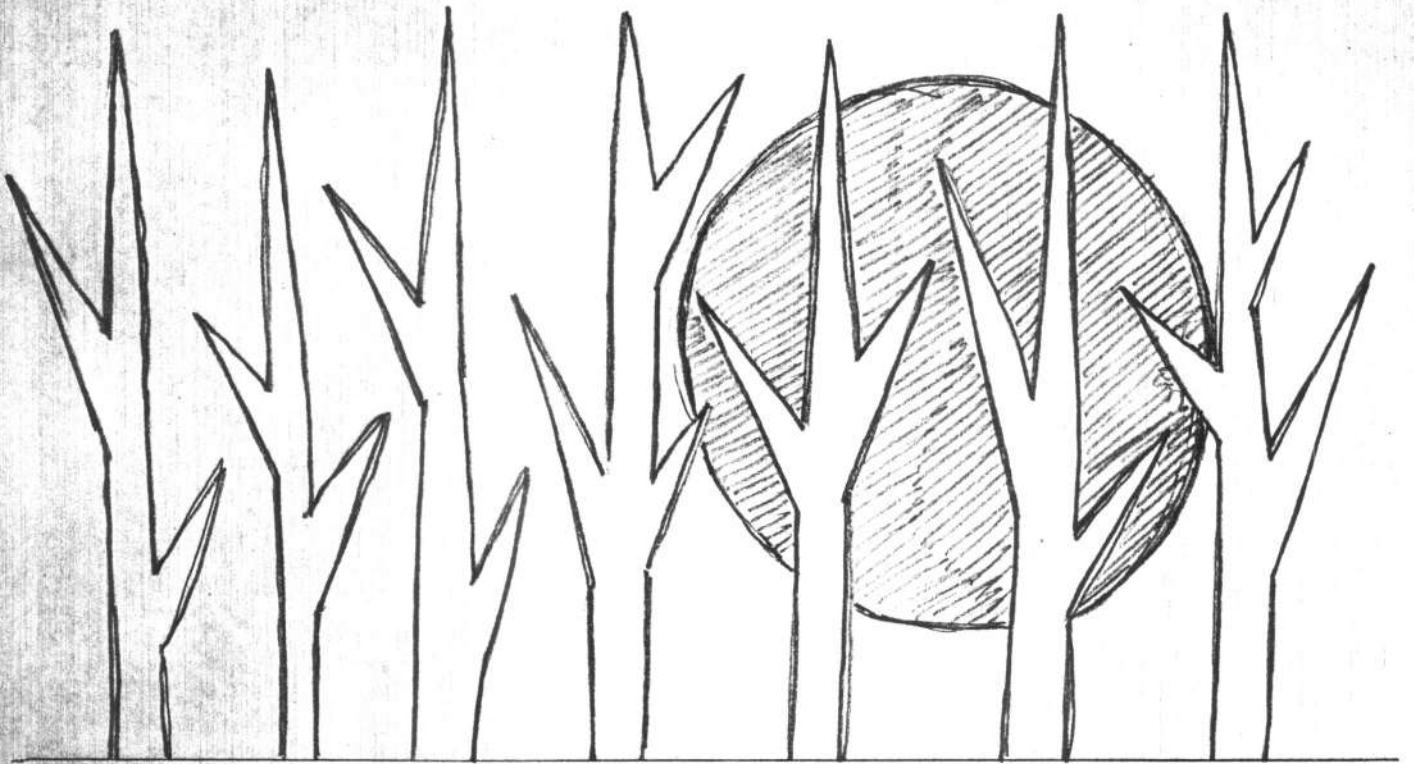

191
Sept 191

page 11. / page 7
bottom / top.
prickly
pear.

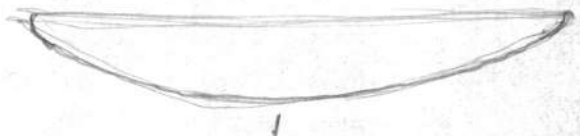
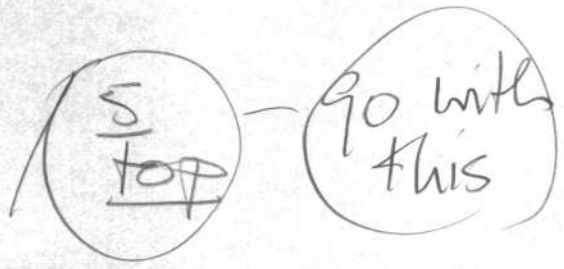

? hammered /
texture

↳ convex

Grooves / scratches / lines.
- in gesso.



? horns in 2 colors

○ round + contrast
colour tip +
collar at base.

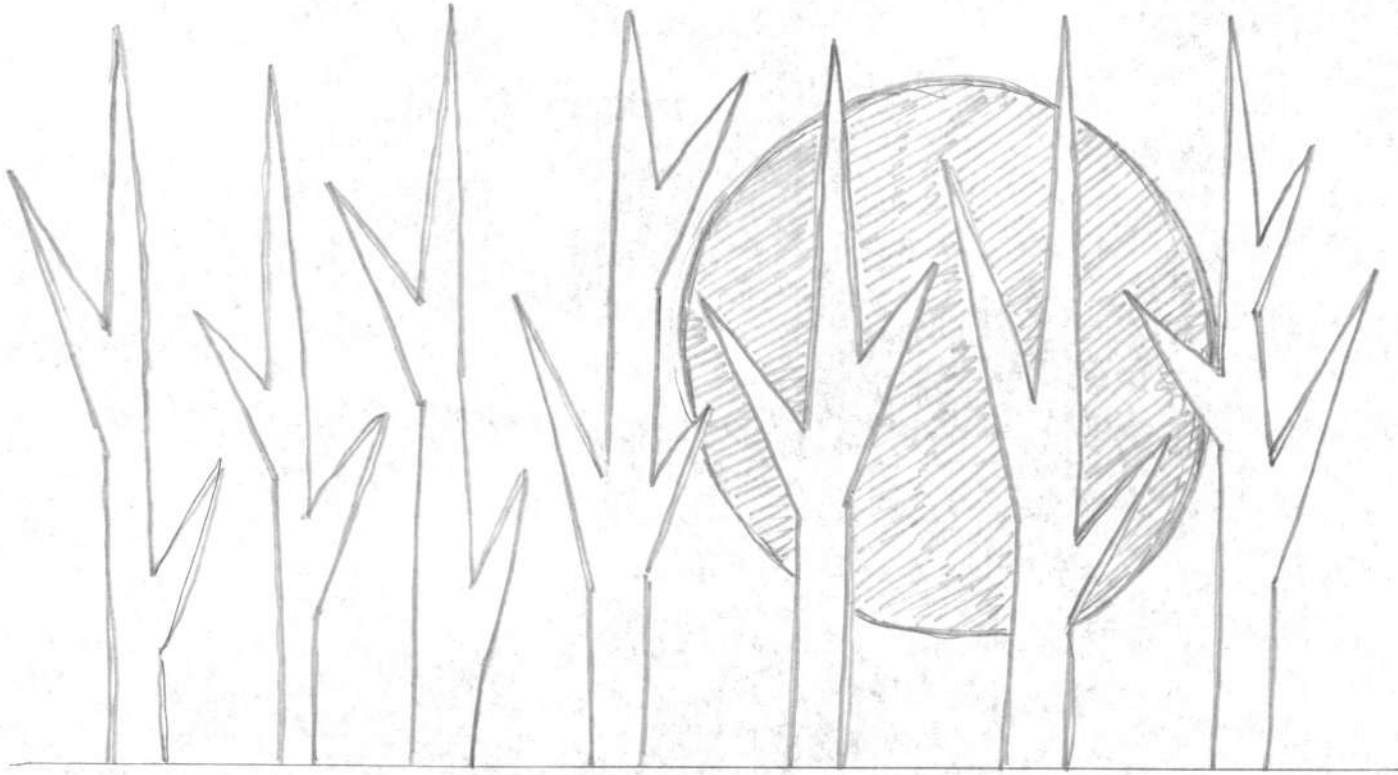
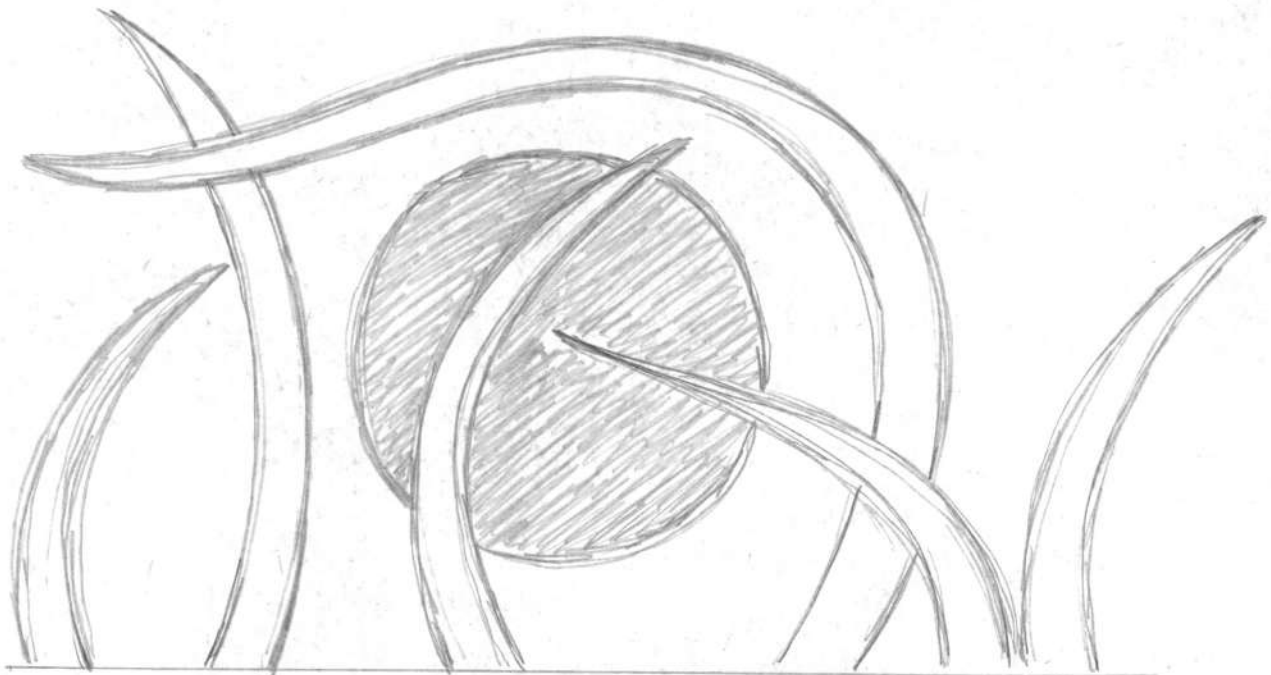

DEREK FROST ASSOCIATES
COPYRIGHT

1:10
Sept '91

? Improved position

Water gilded / distressed
morn - white gold.

5.

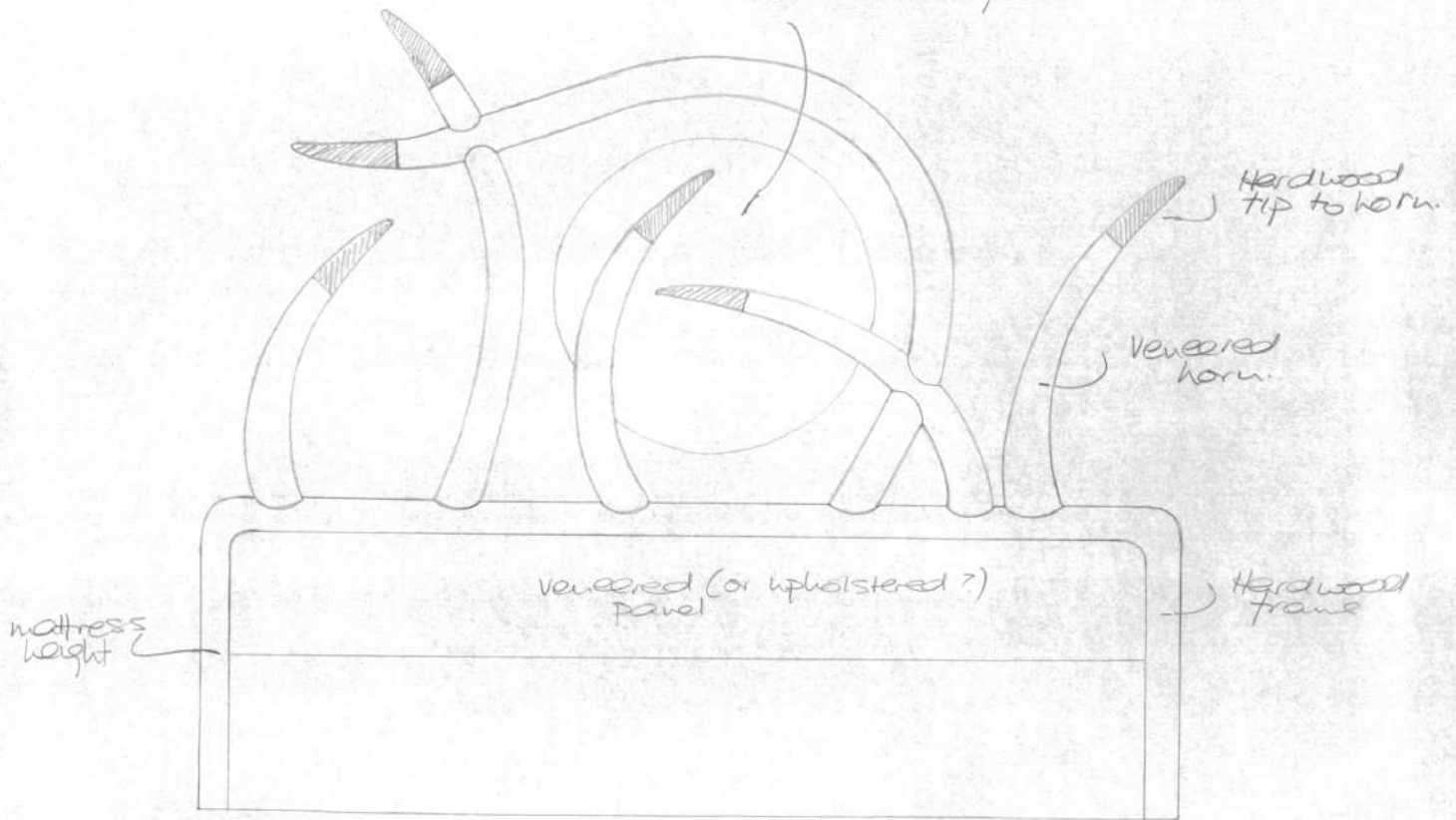

Bed Head for Charles Cecil

1:10
Oct '91

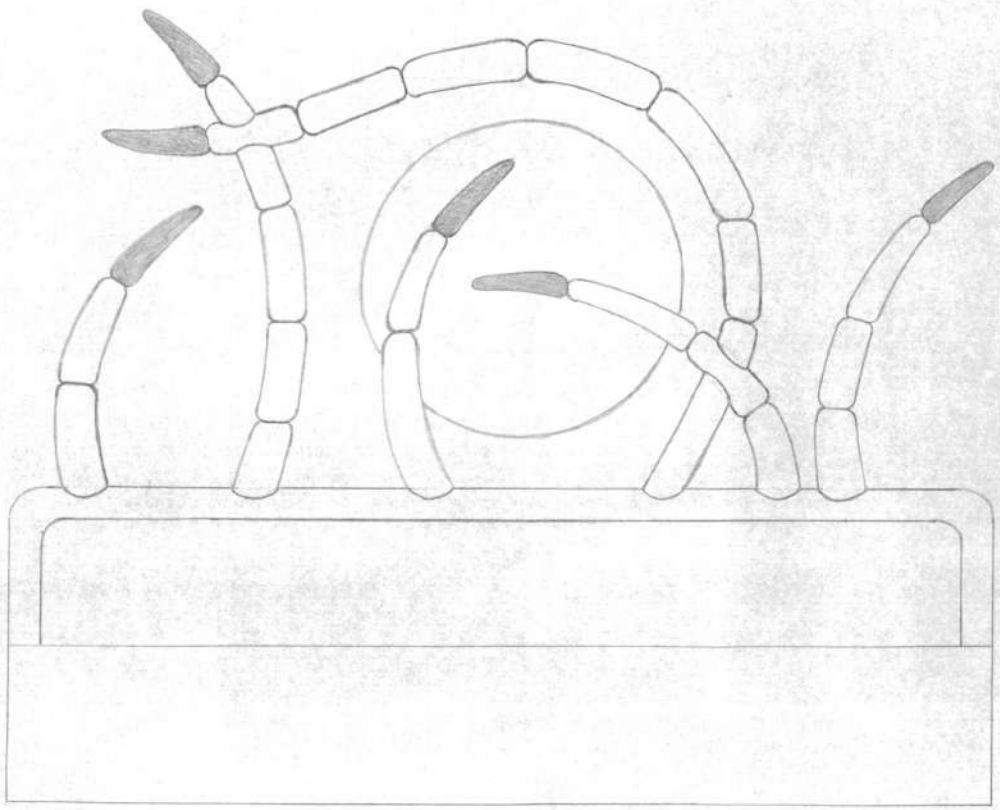

Bed Head for Charles Cecil
Front Elevation

1:10
Oct. '91

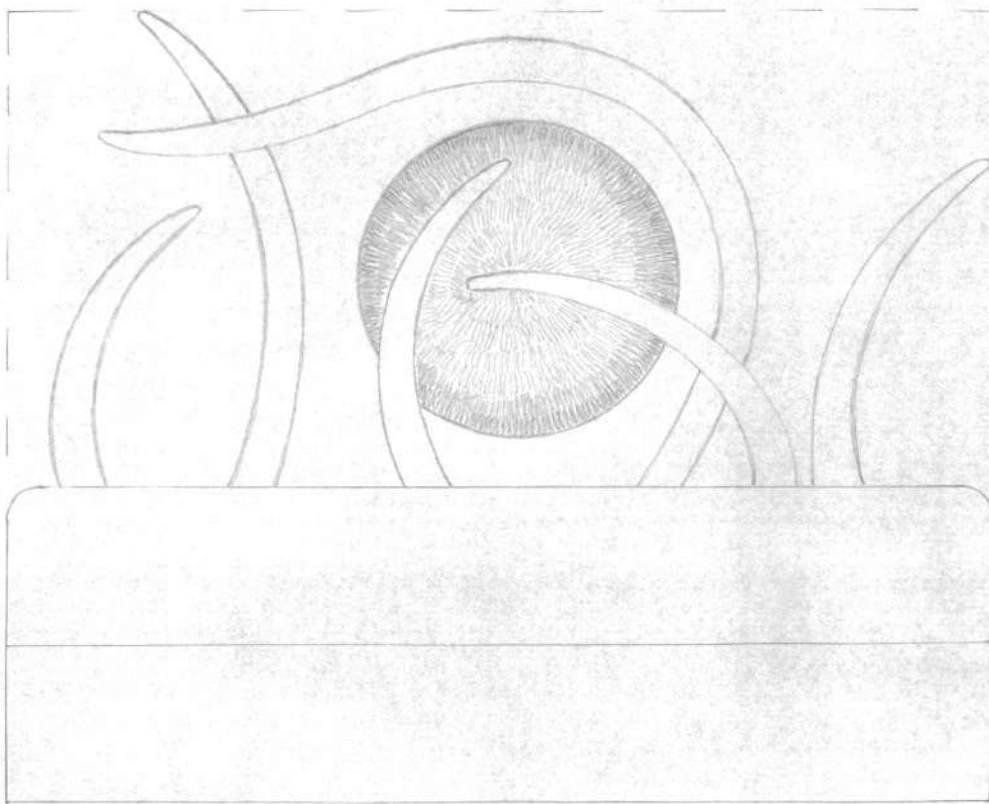

Bed Head for Charles Cecil
Front Elevation

1:10
Oct 191



Insert
contrast
hd. hd.
along ridge
line + down
outside vertical
edges frame.

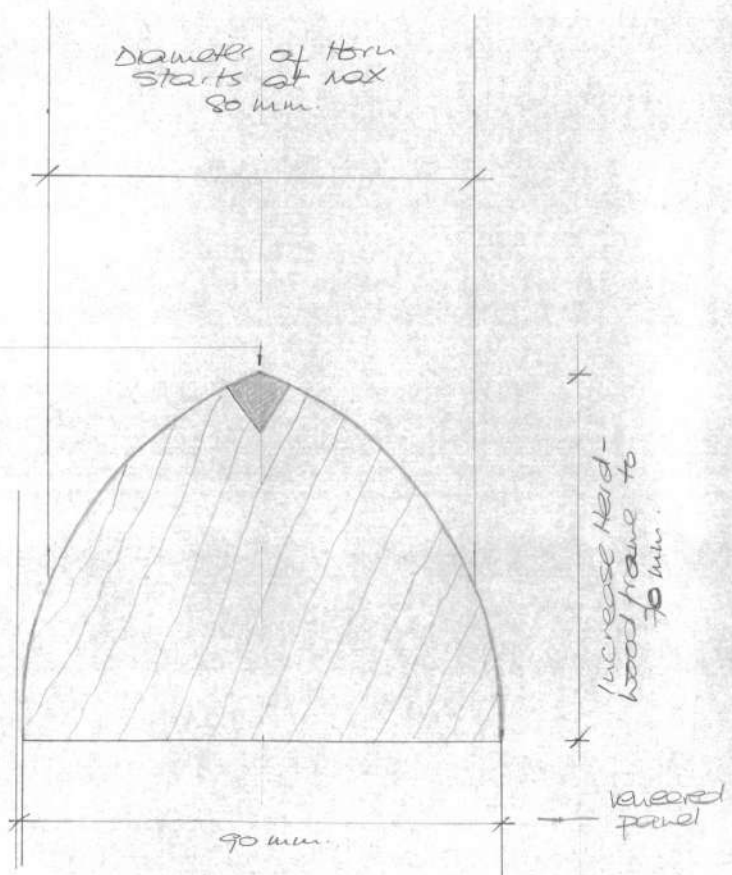

Details - Bed Head
for Charles Cecil

Full scale - Oct '91.

? Connect moon to wall to strengthen (NB existing banding).

3.

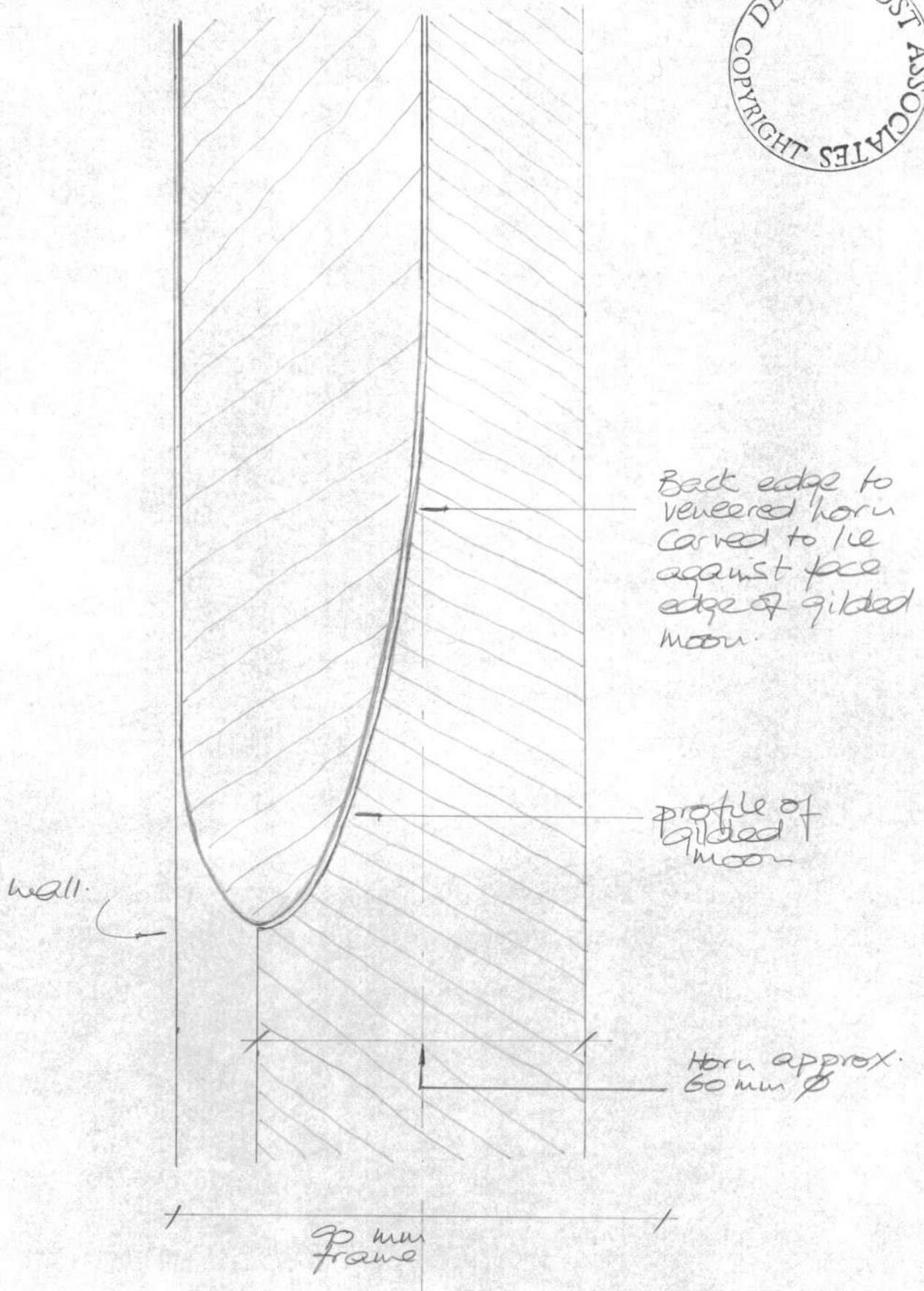

SECTION
Bedhead for Charles
Cecil.

Full Scale
Oct '91



f.

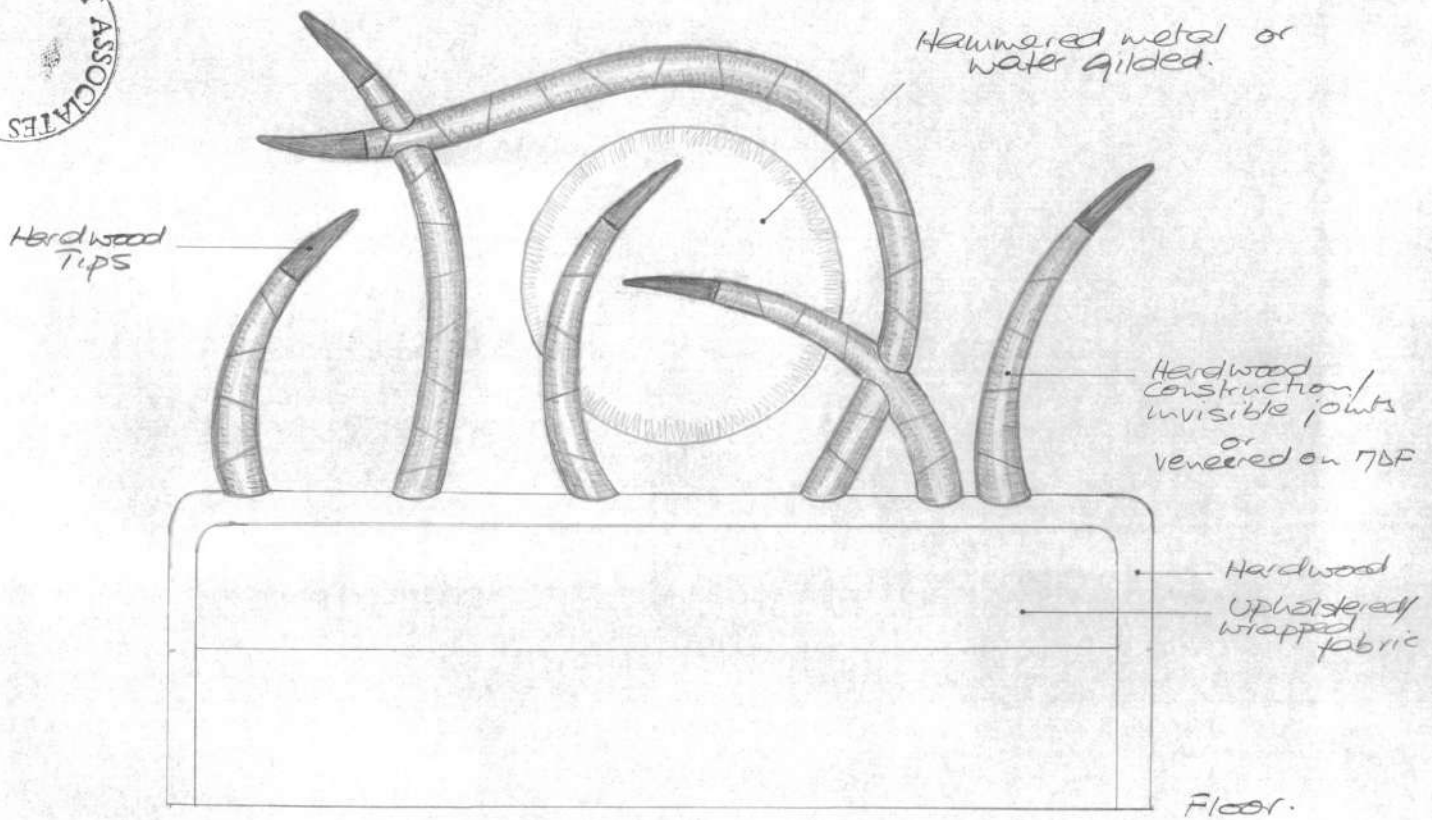

Bed Head for Charles Cecil
Front Elevation

1:10
Oct 1911

